



Pre-K March Packet

Dear Families,

Attached is a packet for your scholar to complete while at home.
Please have your scholar finish one page (front and back) per day.

Thank you

Due: Upon Returning to School

This assignment will count at 1 test grade

Name: _____

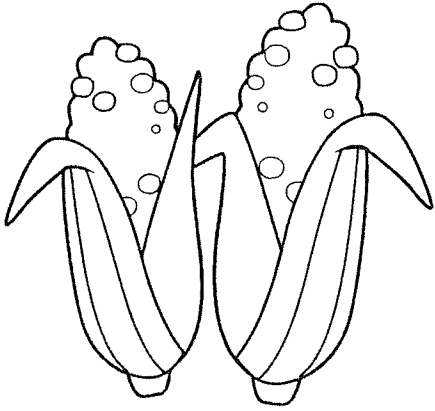
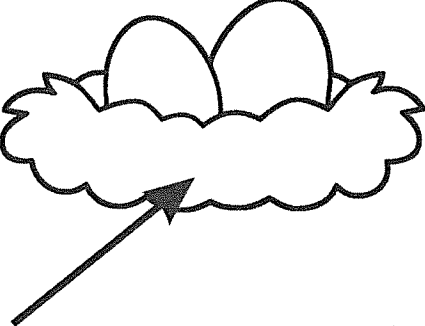
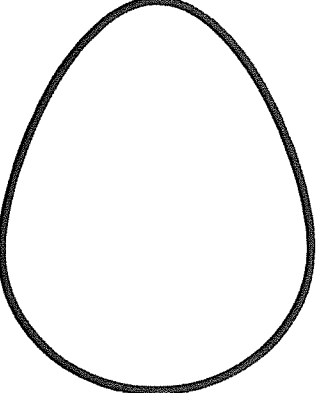
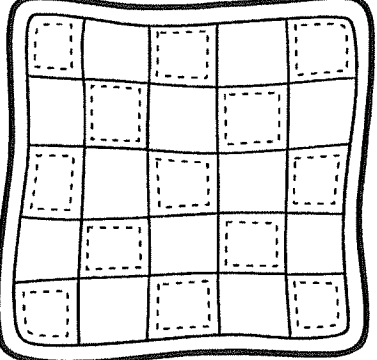
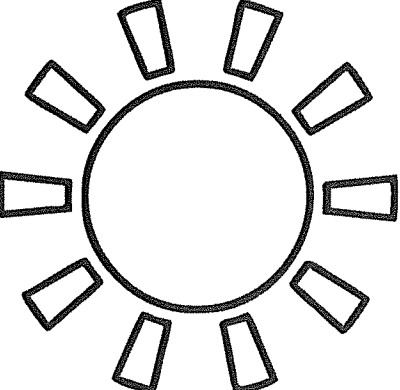
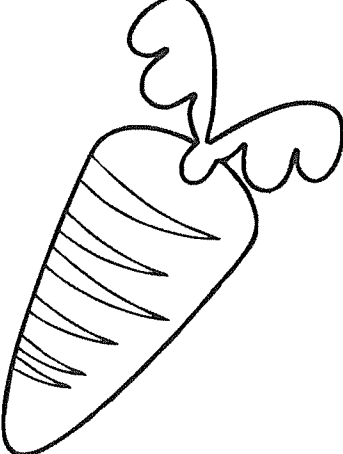

Name:

What sound do the pictures begin with?

 <p data-bbox="620 478 760 613">c</p> <p data-bbox="620 697 760 831">v</p>	 <p data-bbox="1247 478 1386 613">a</p> <p data-bbox="1247 697 1386 831">n</p>
 <p data-bbox="620 991 760 1125">e</p> <p data-bbox="620 1209 760 1344">r</p>	 <p data-bbox="1247 991 1386 1125">g</p> <p data-bbox="1247 1209 1386 1344">q</p>
 <p data-bbox="620 1516 760 1650">x</p> <p data-bbox="620 1734 760 1869">s</p>	 <p data-bbox="1247 1516 1386 1650">c</p> <p data-bbox="1247 1734 1386 1869">u</p>

Name:

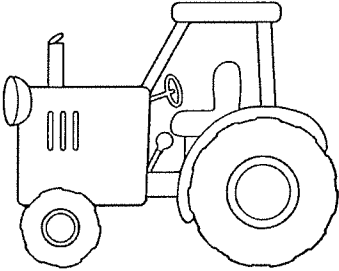
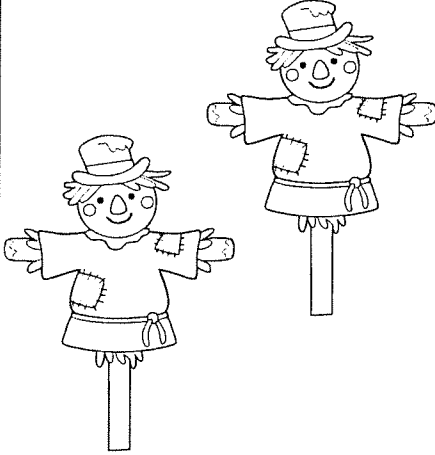
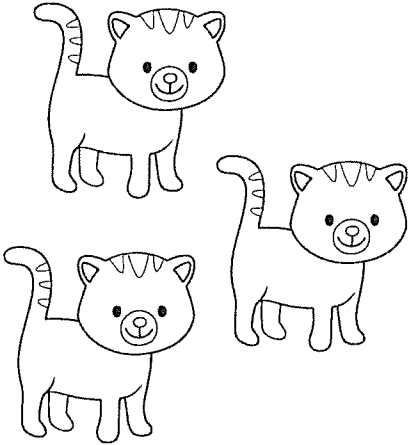
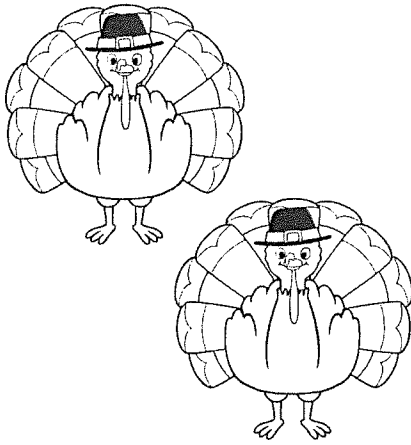
How many are there?

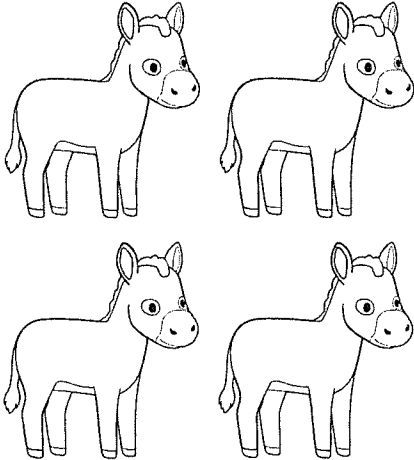
	<p>①</p> <p>②</p> <p>③</p>		<p>①</p> <p>②</p> <p>③</p>
	<p>②</p> <p>③</p> <p>④</p>		<p>②</p> <p>③</p> <p>④</p>
	<p>③</p> <p>④</p> <p>⑤</p>		<p>③</p> <p>④</p> <p>⑤</p>

Name:

Cut and paste the missing letters.

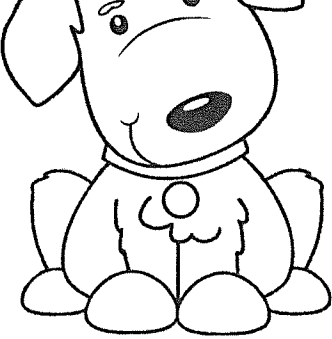
A	B			
D		F		
G	H	I	J	
	M	N		P
Q		S		U
	W		Y	



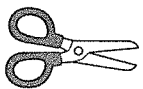







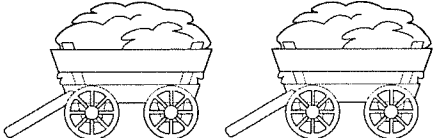
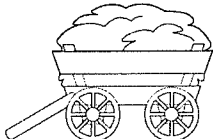
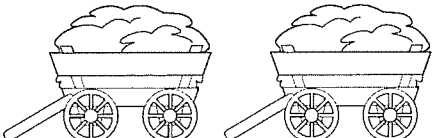



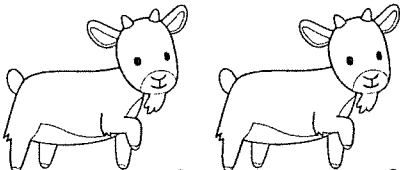
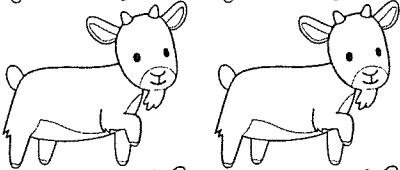
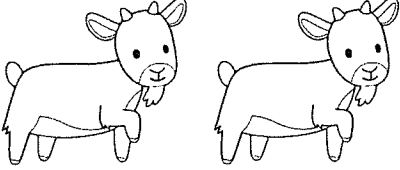



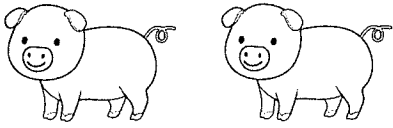
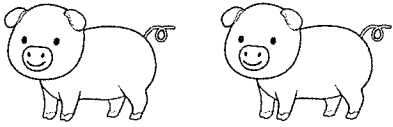
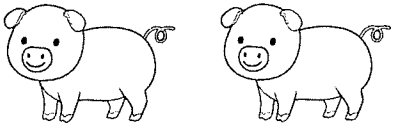
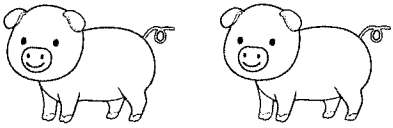



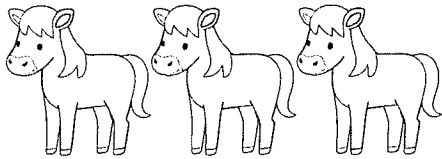
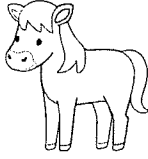

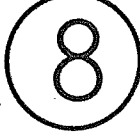
By Lavinia Pop © 2014

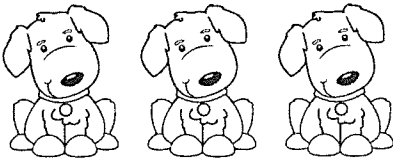
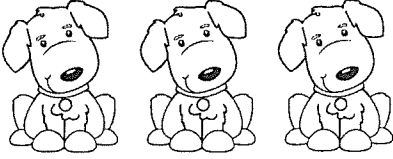

C	T	E	X	L
R	O	V	K	Z

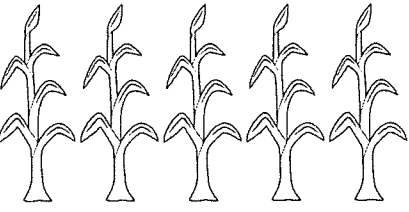
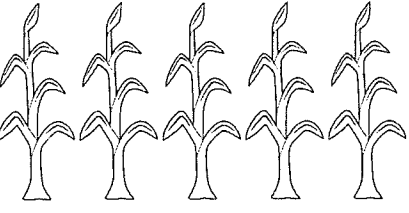









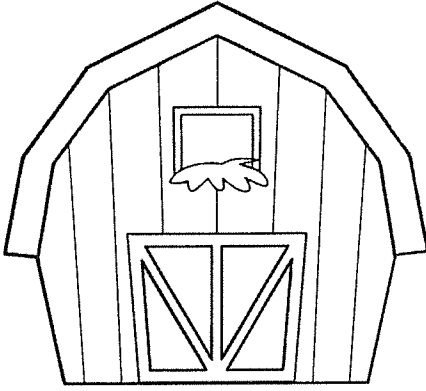

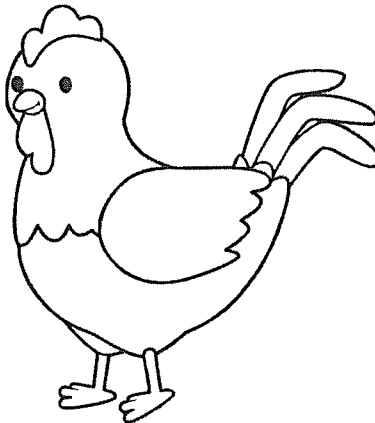
Name: _____

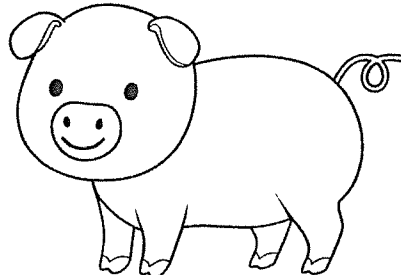
How many are there?

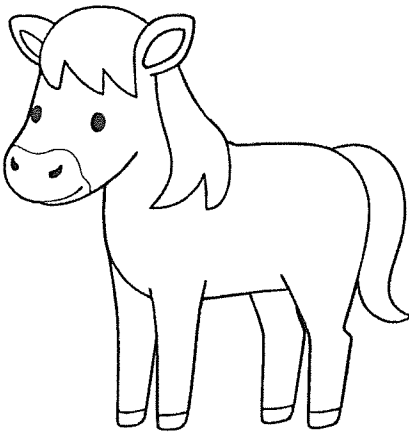
Name:

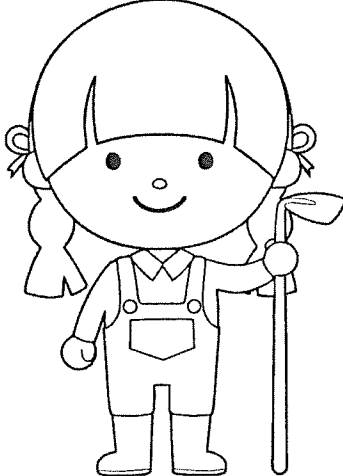
What sound do the pictures begin with?

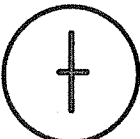
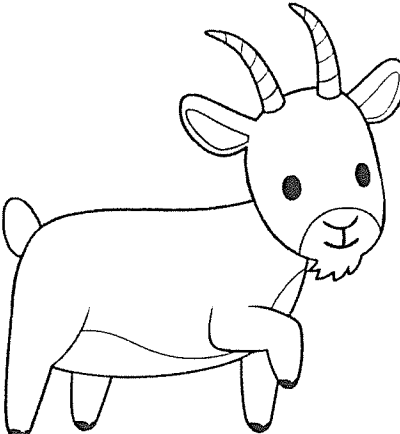
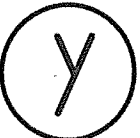
Name:

--

Count and write how many.

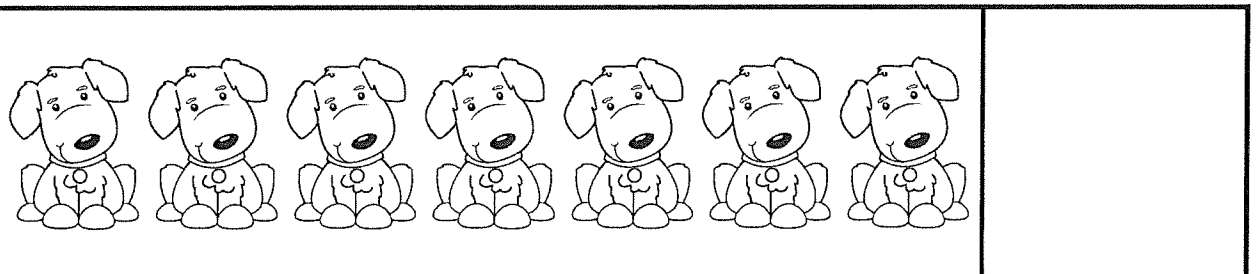
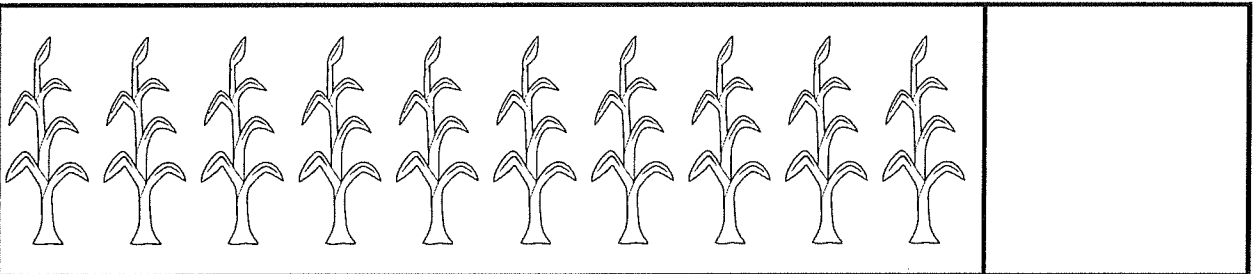
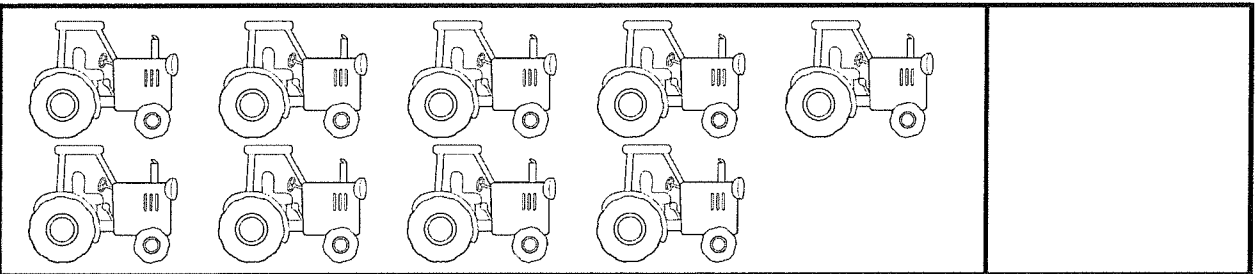
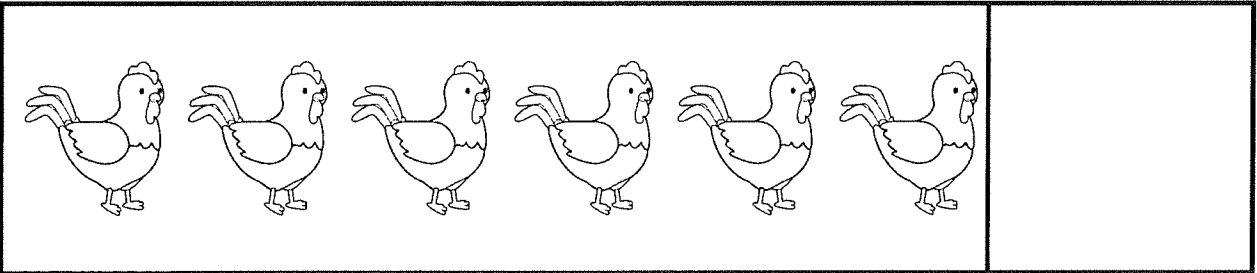
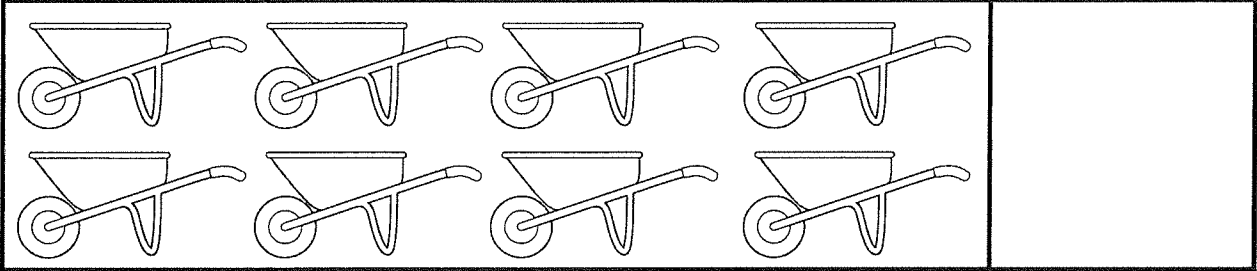

Name:

--

Which pictures begin with the same sound as...

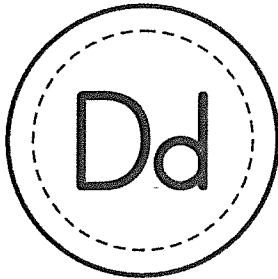

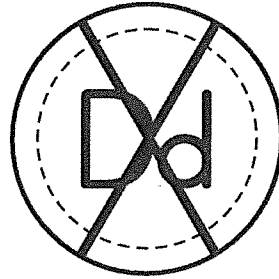
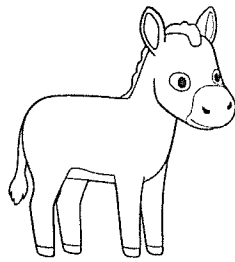

donkey

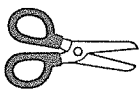

By Lavinia Pop © 2014

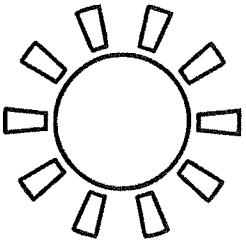
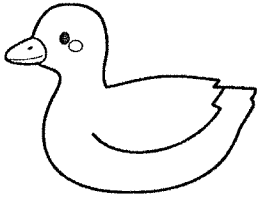
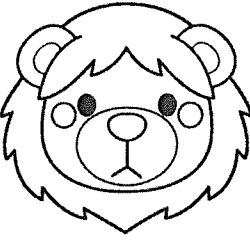
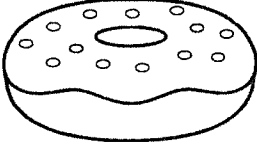
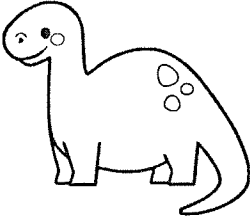
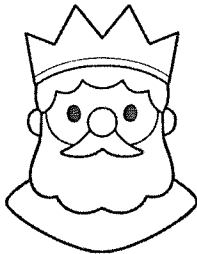

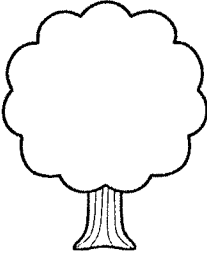
Name:

--

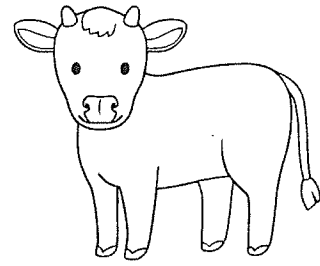

Write the missing numbers.

1	2	3		5
	7	8	9	10

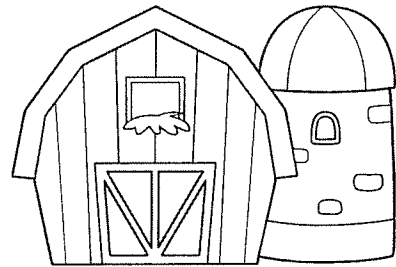

Write the missing numbers.

1		3	4	
6	7	8		10



Write the missing numbers.

	2		4	5
6	7		9	

Name:

Match the capital letter on the baskets to the correct lowercase letter on the apples.

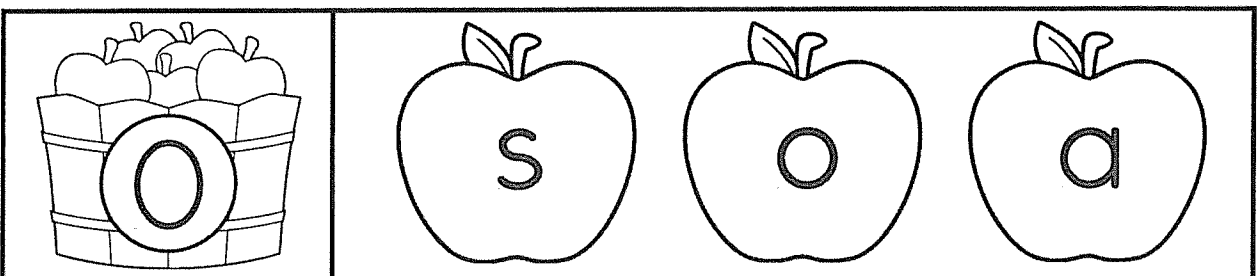
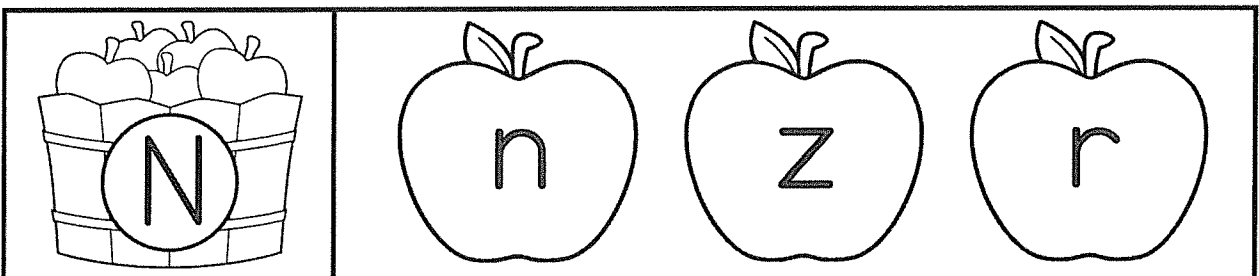
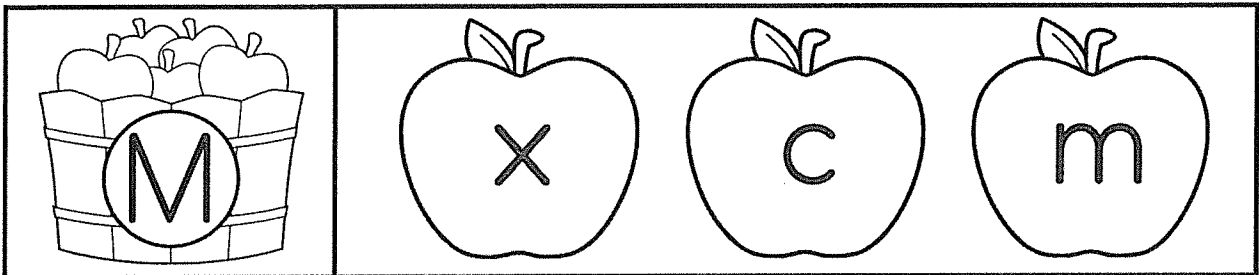
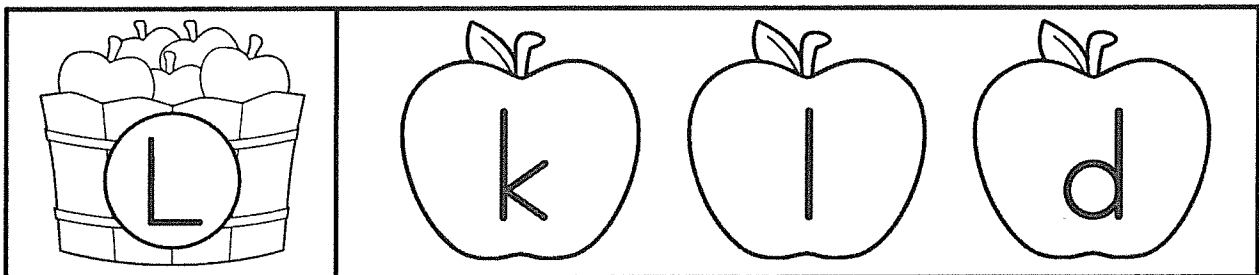
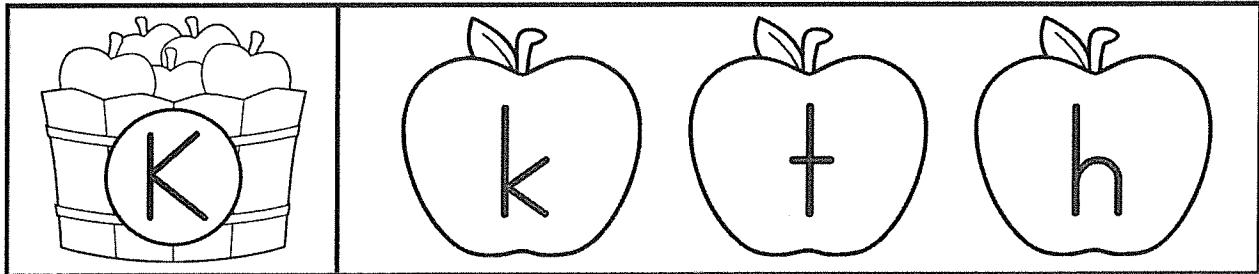

Name:

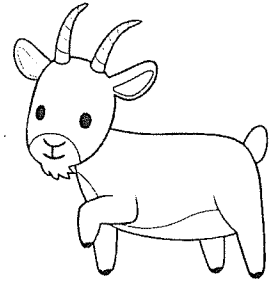

Write the missing numbers.

1	2	3		5
6		8	9	10
11	12		14	15
	17	18	19	20

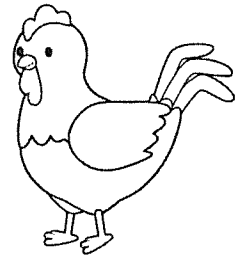

Write the missing numbers.

1		3	4	5
6	7		9	10
11		13	14	15
16	17	18		20

Name:

Match the capital letter on the baskets to the correct lowercase letter on the apples.

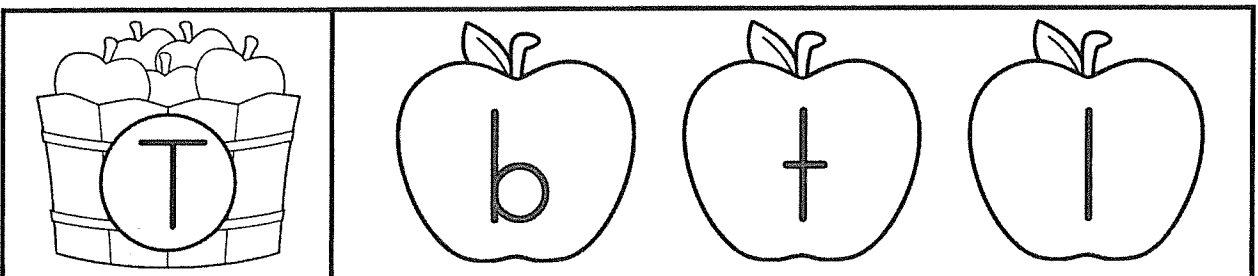
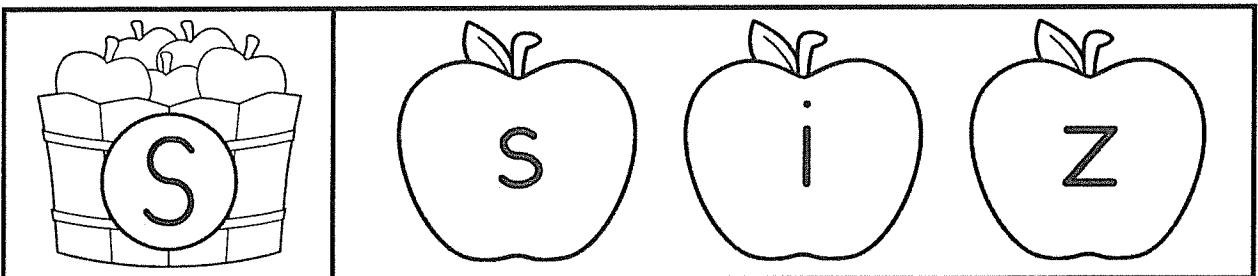
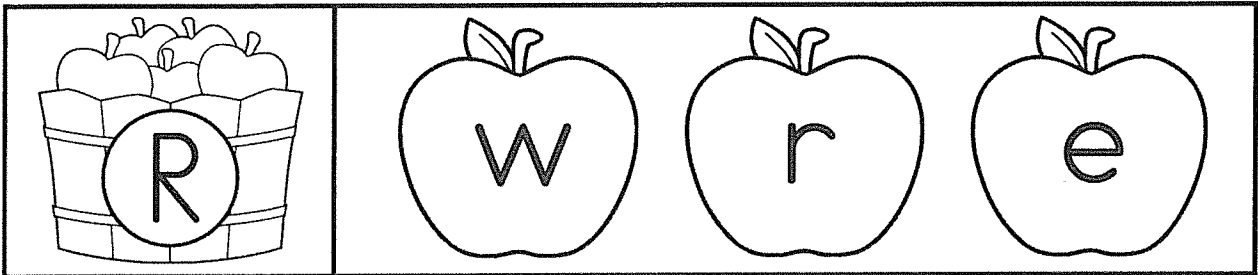
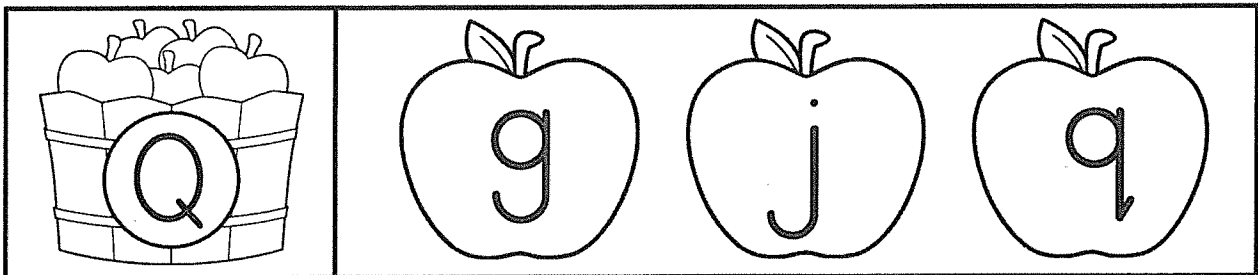
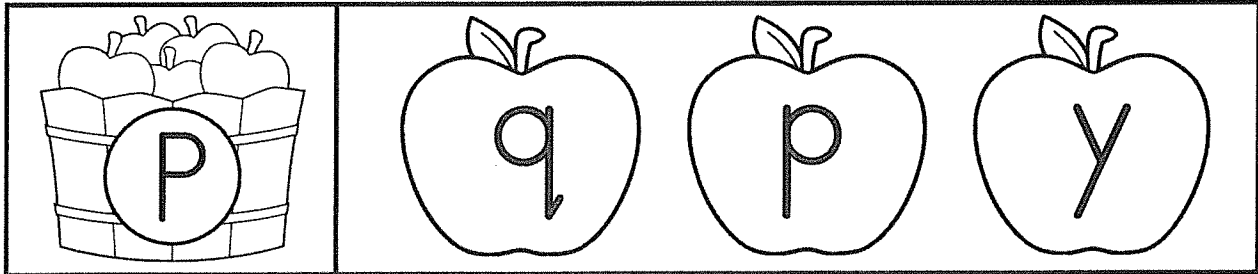

Name: _____

Which picture is different?

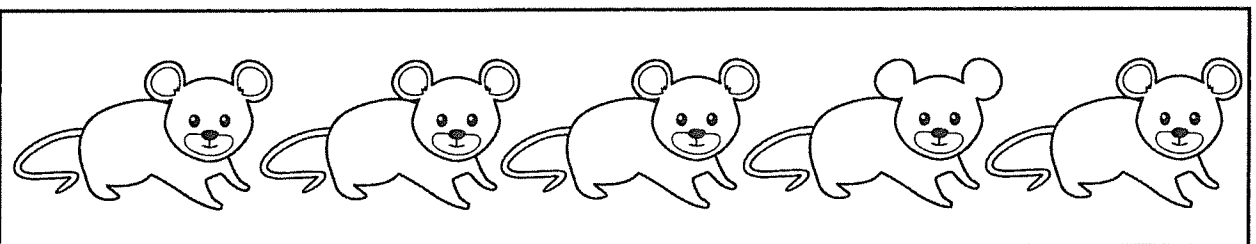
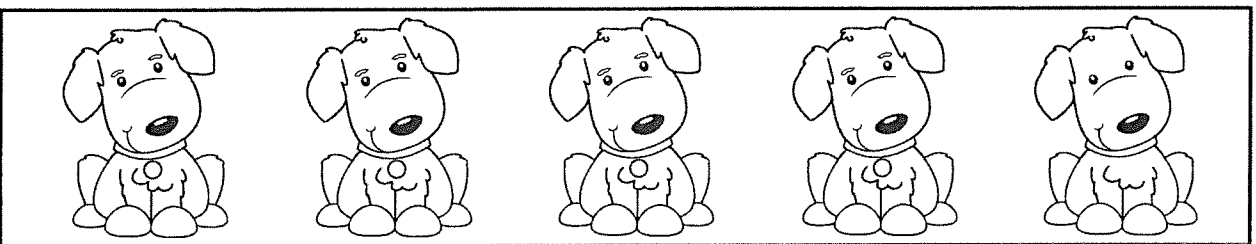
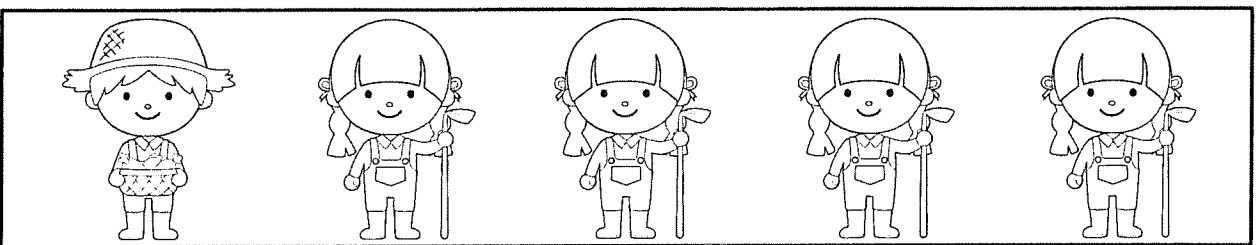
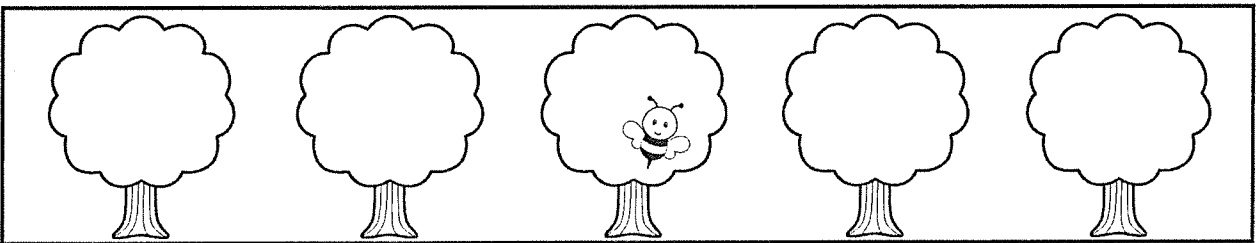
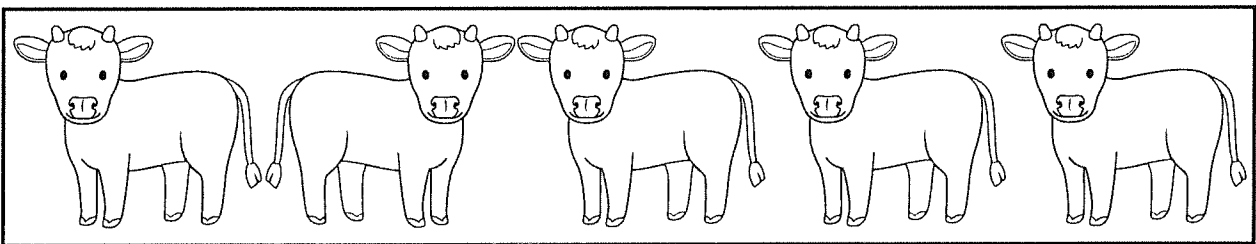
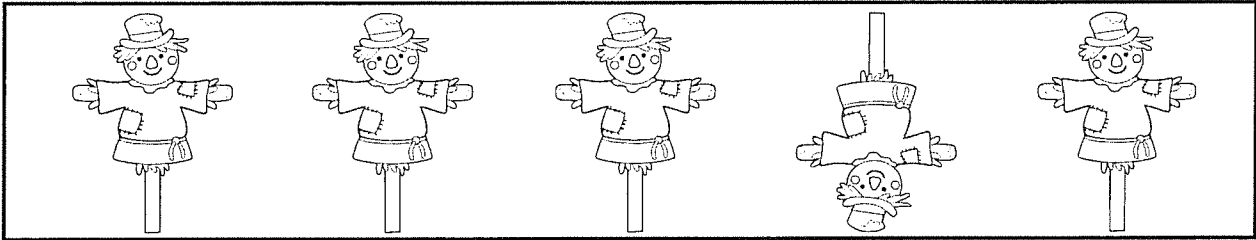

Name:

Match the capital letter on the baskets to the correct lowercase letter on the apples.

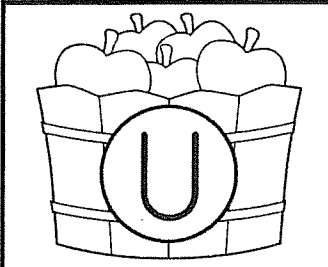
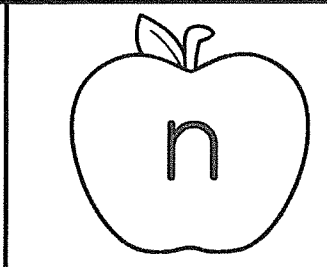
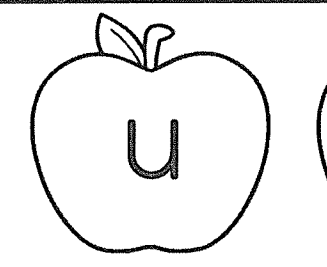
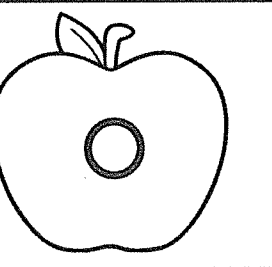
			
---	---	--	---

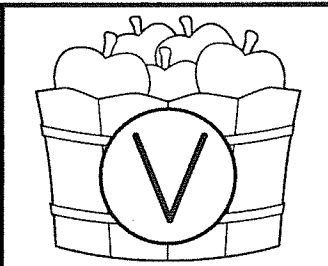
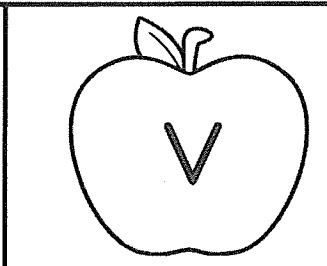
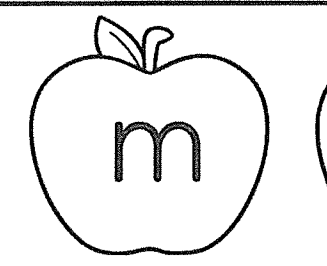
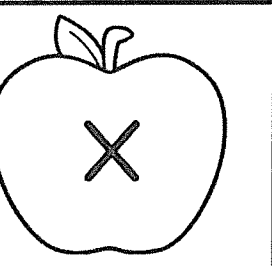
			
--	--	---	--

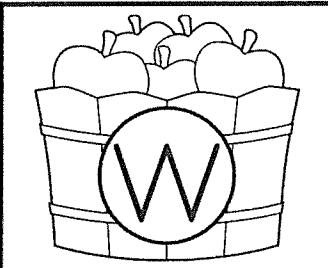
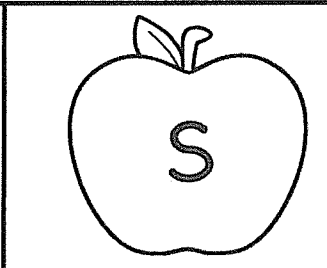
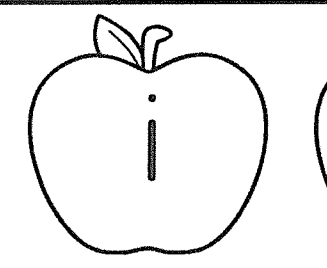
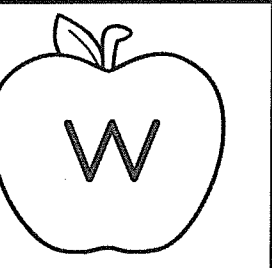
			
---	---	--	---

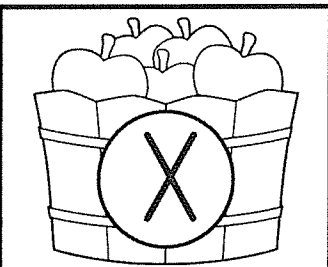
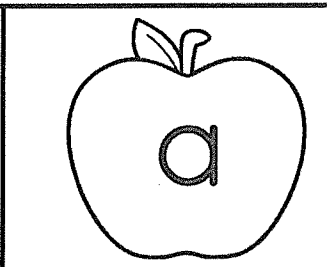
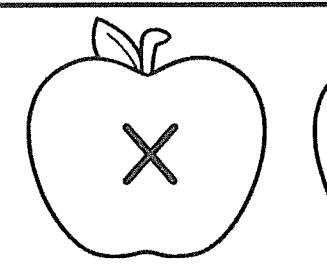
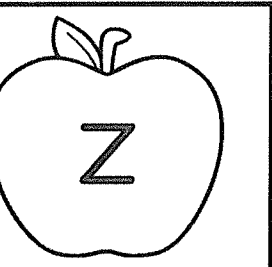
			
---	---	--	---

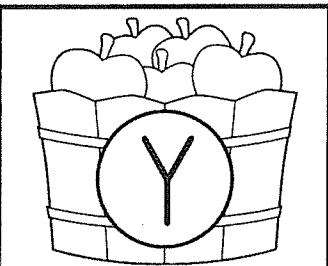
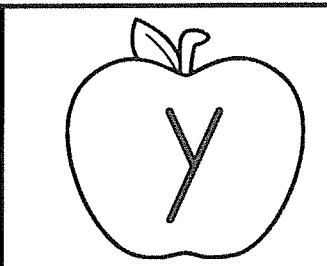
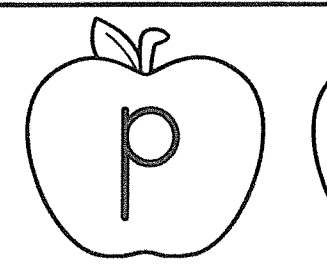
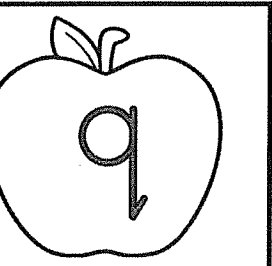
			
---	---	--	---

Name:

Blank box for writing the name.

Which has more?

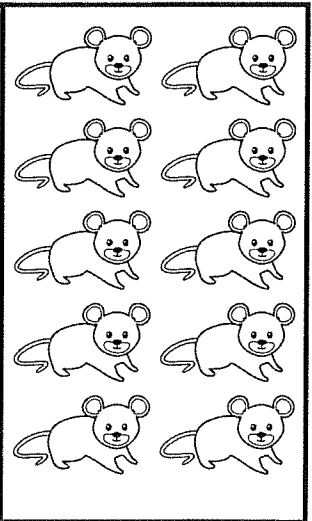
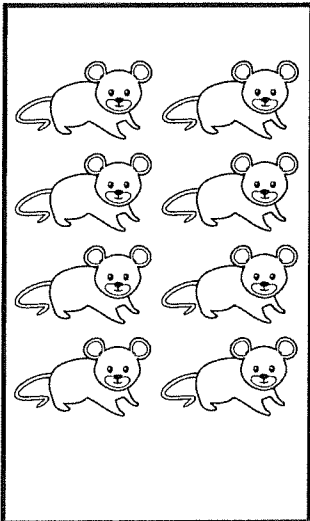
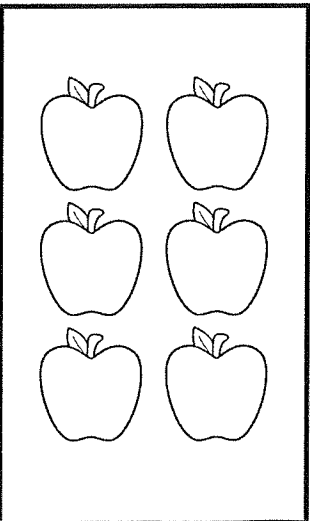
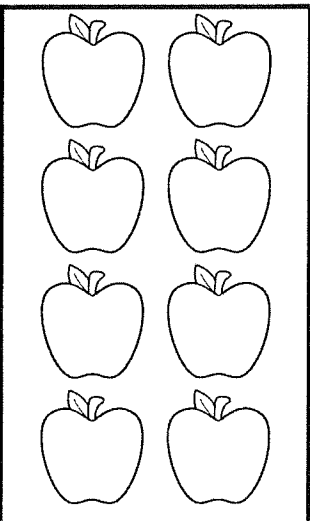
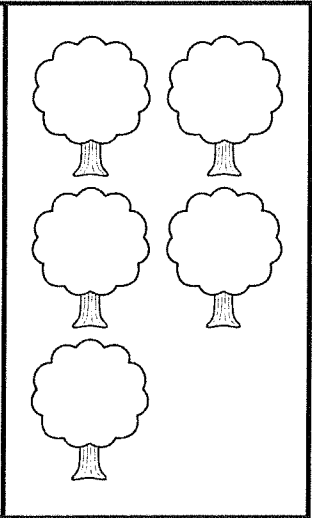
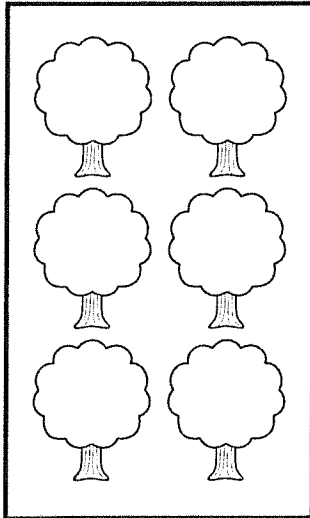
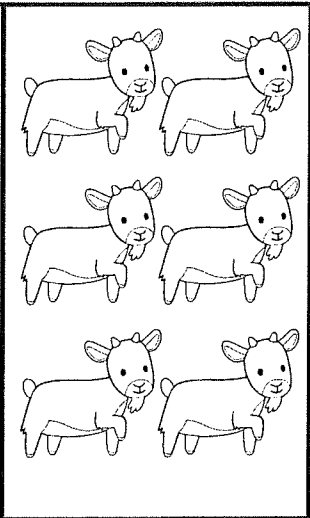
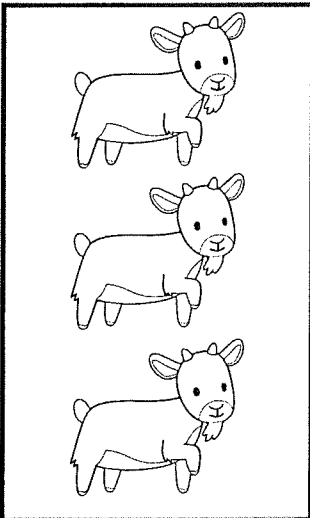
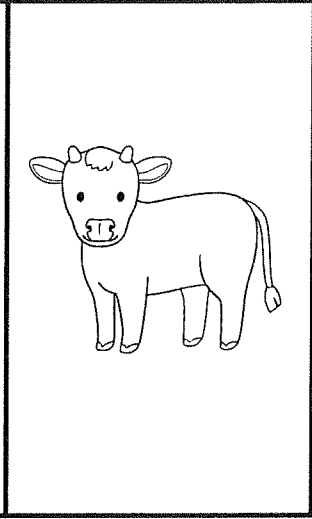
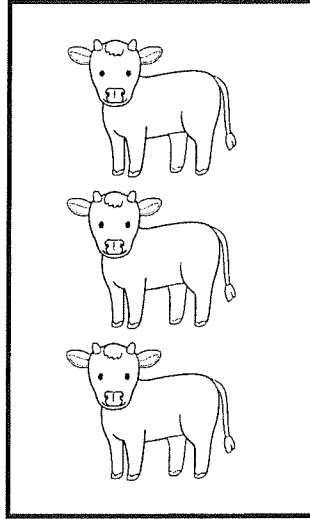
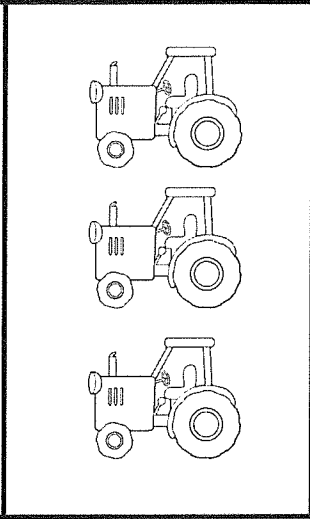
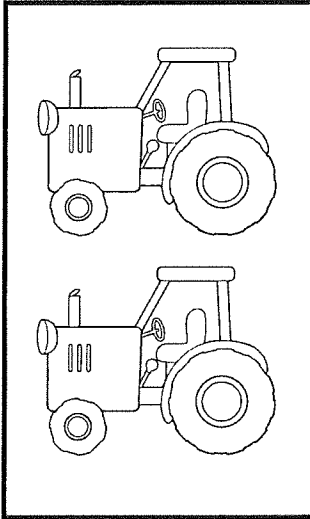

Name:

Match the capital letter on the baskets to the correct lowercase letter on the apples.

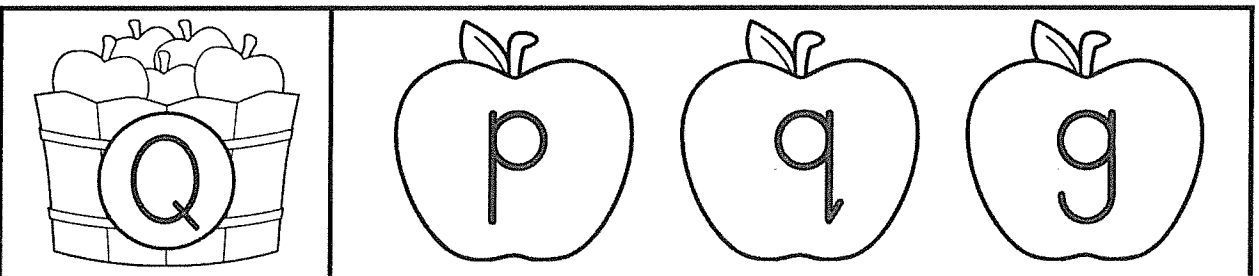
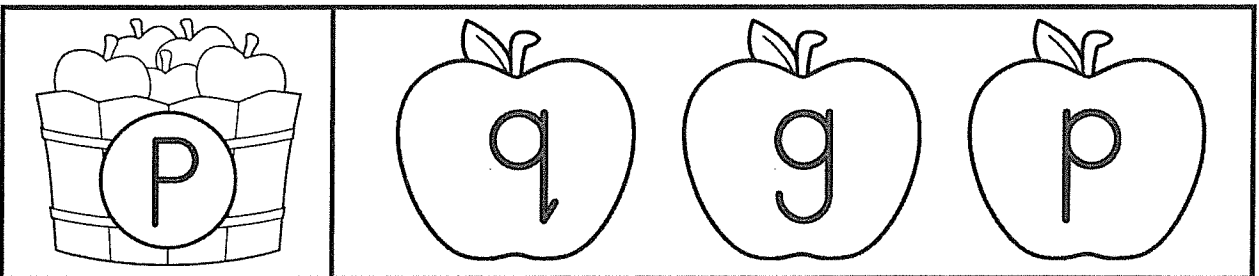
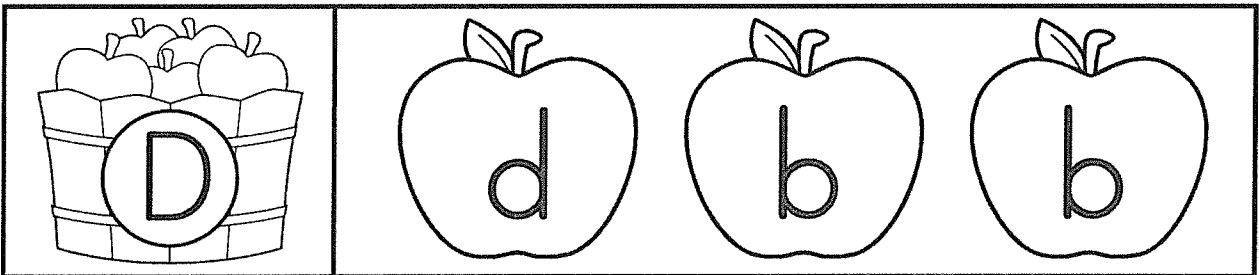
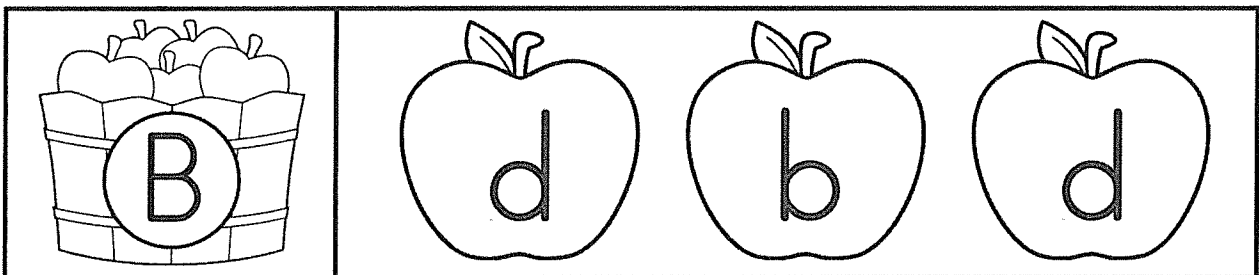
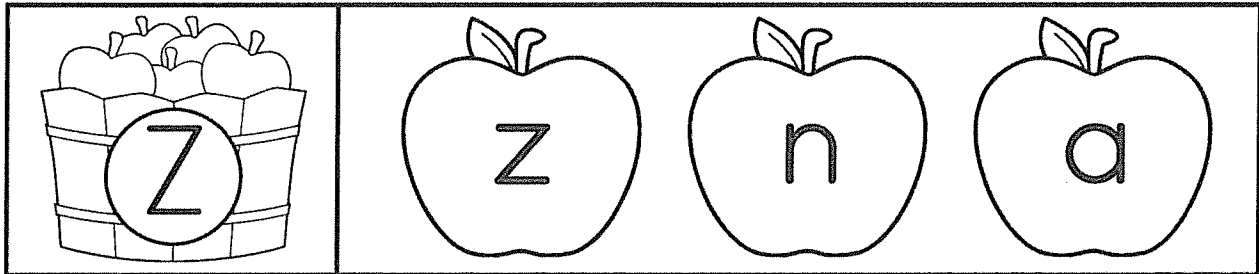

Name: _____

Add the following:

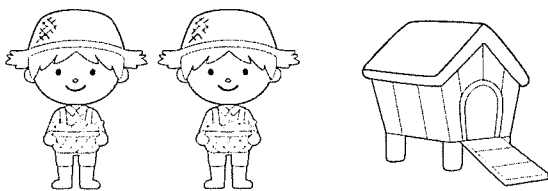
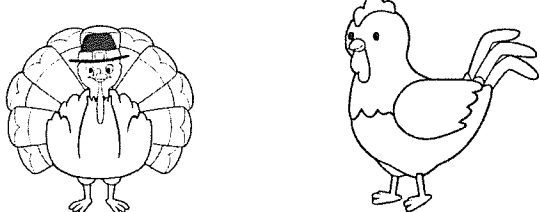
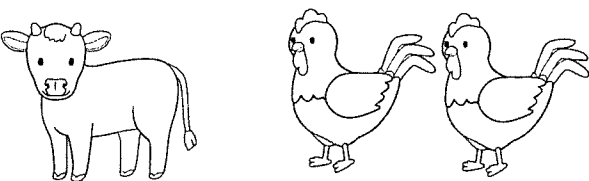
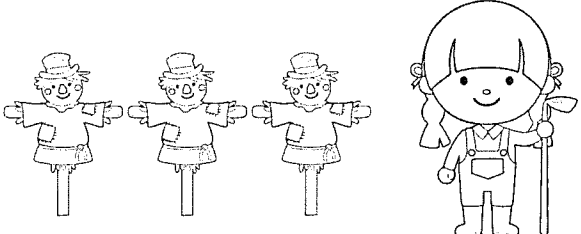
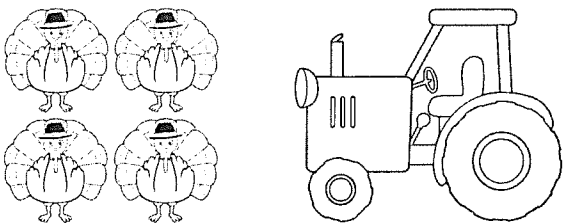
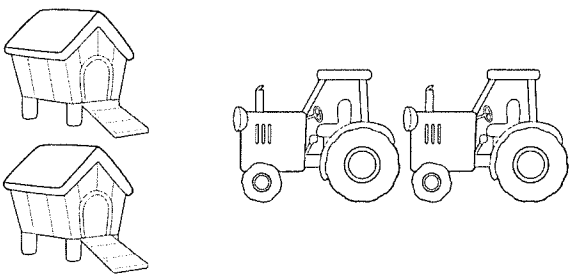
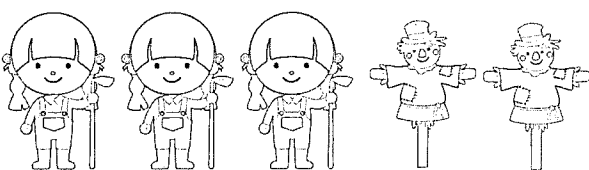
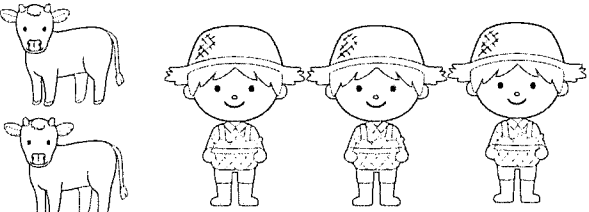
 $\underline{\quad} + \underline{\quad} = \underline{\quad}$	 $\underline{\quad} + \underline{\quad} = \underline{\quad}$
 $\underline{\quad} + \underline{\quad} = \underline{\quad}$	 $\underline{\quad} + \underline{\quad} = \underline{\quad}$
 $\underline{\quad} + \underline{\quad} = \underline{\quad}$	 $\underline{\quad} + \underline{\quad} = \underline{\quad}$
 $\underline{\quad} + \underline{\quad} = \underline{\quad}$	 $\underline{\quad} + \underline{\quad} = \underline{\quad}$

Name: _____

Match the capital letter on the baskets to the correct lowercase letter on the apples.

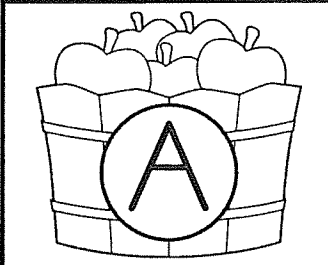
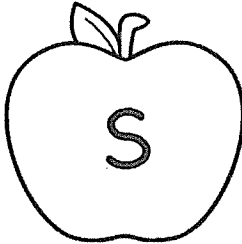
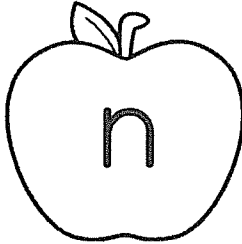
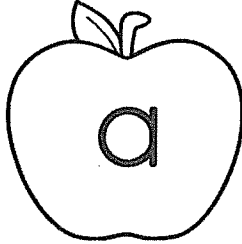
			
---	---	--	---

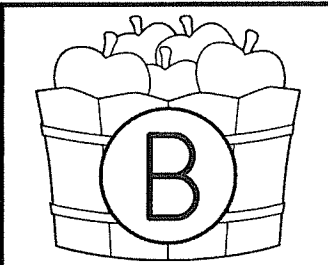
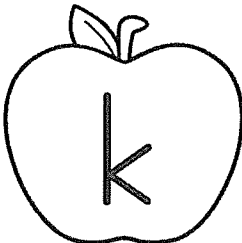
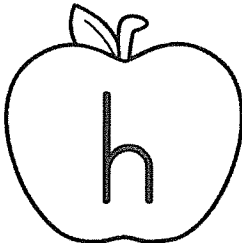
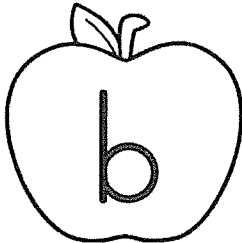
			
--	--	---	--

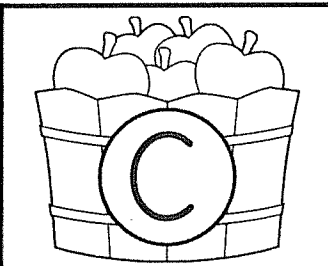
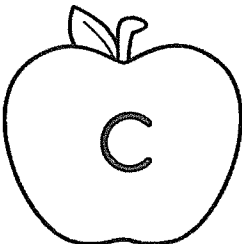
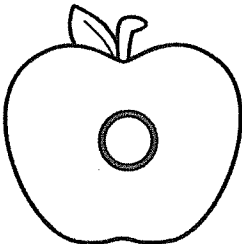
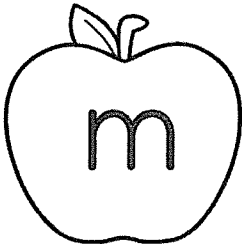
			
---	---	--	---

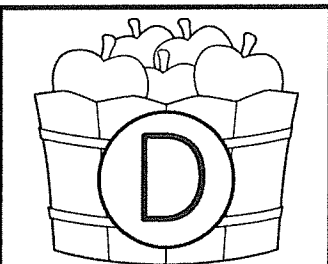
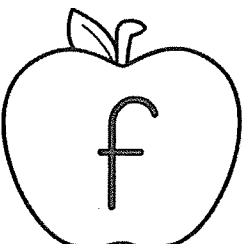
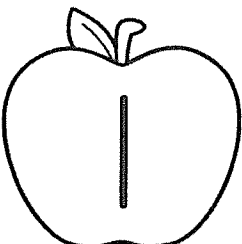
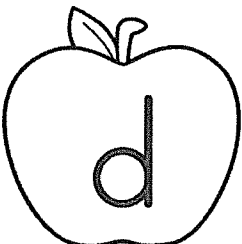
			
---	---	--	---

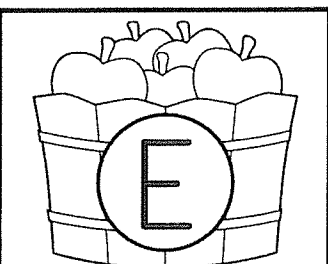
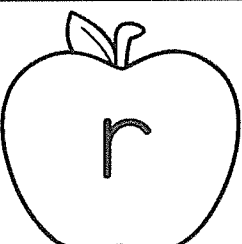
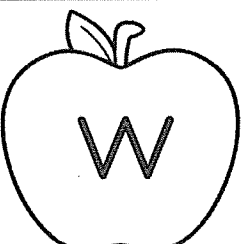
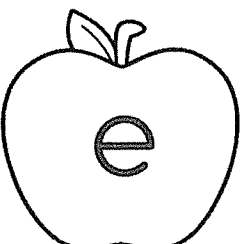
			
---	---	--	---

Name: _____

Add the following:

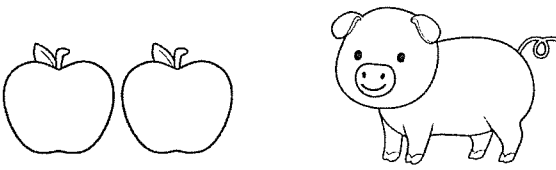
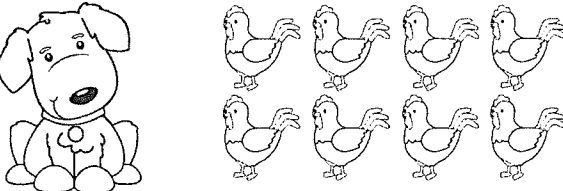
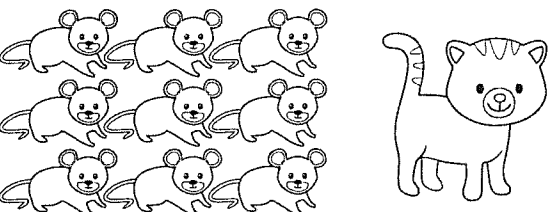
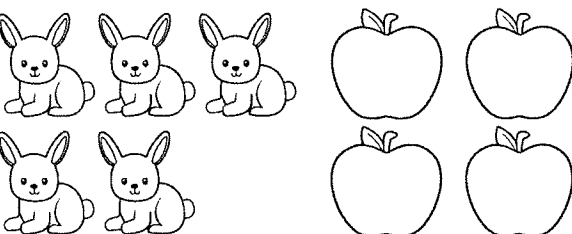
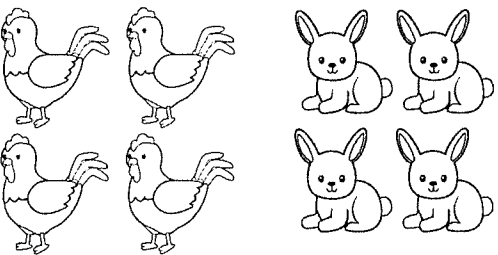
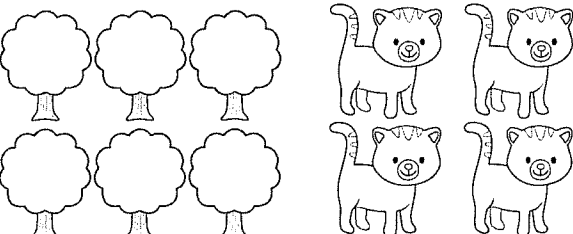
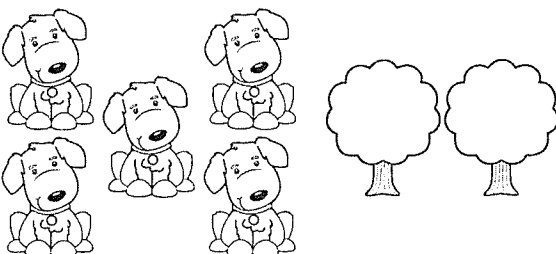
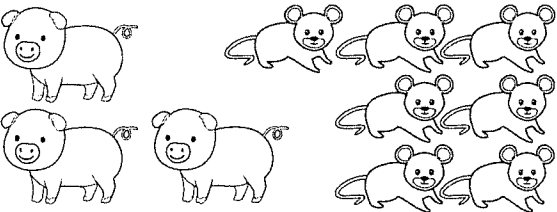
 $\underline{\quad} + \underline{\quad} = \underline{\quad}$	 $\underline{\quad} + \underline{\quad} = \underline{\quad}$
 $\underline{\quad} + \underline{\quad} = \underline{\quad}$	 $\underline{\quad} + \underline{\quad} = \underline{\quad}$
 $\underline{\quad} + \underline{\quad} = \underline{\quad}$	 $\underline{\quad} + \underline{\quad} = \underline{\quad}$
 $\underline{\quad} + \underline{\quad} = \underline{\quad}$	 $\underline{\quad} + \underline{\quad} = \underline{\quad}$

Name: _____

Match the capital letter on the baskets to the correct lowercase letter on the apples.

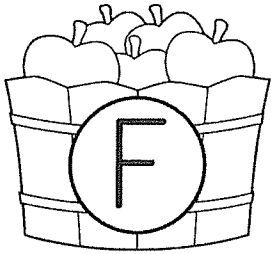
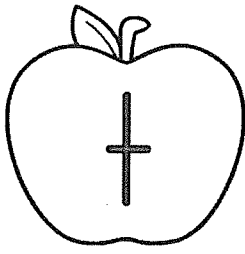
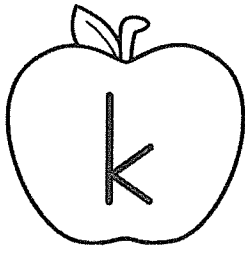
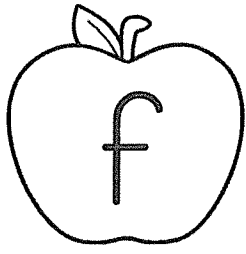
			
---	---	--	---

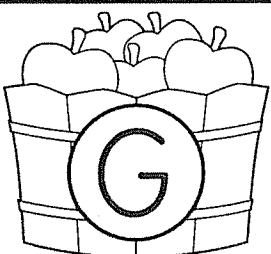
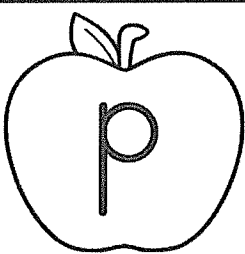
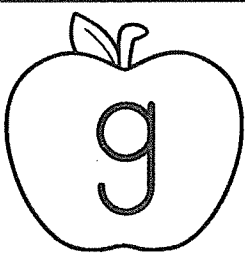
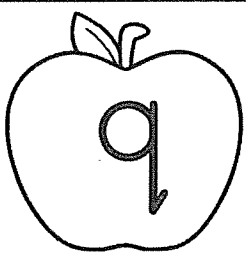
			
--	--	---	--

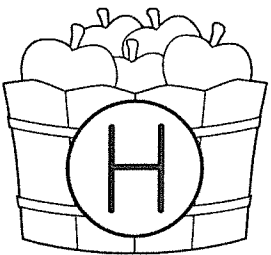
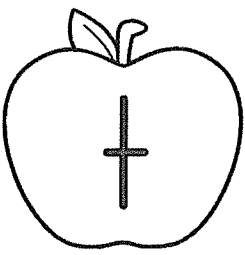
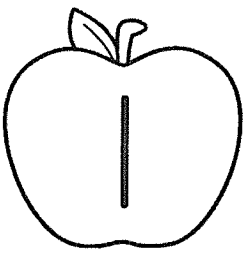
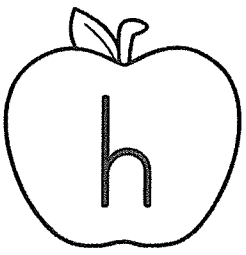
			
---	---	--	---

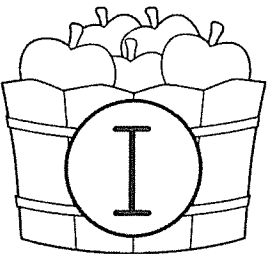
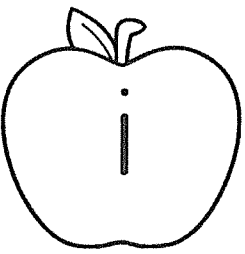
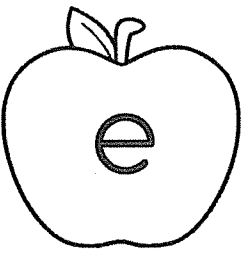
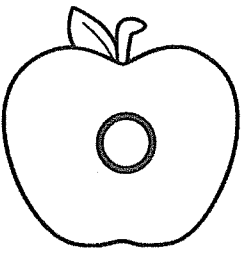
			
---	---	--	---

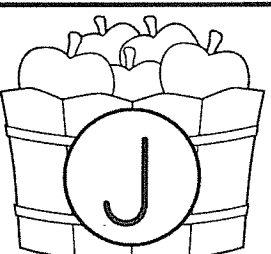
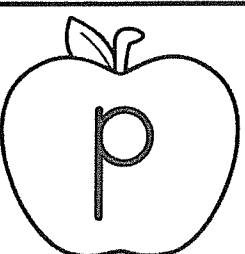
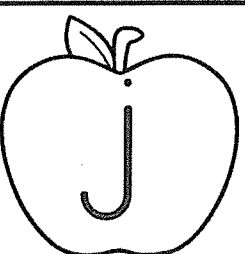
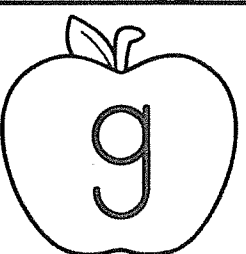
			
---	---	--	---

Name: _____

Count the apples. How many more do you need to make 10?

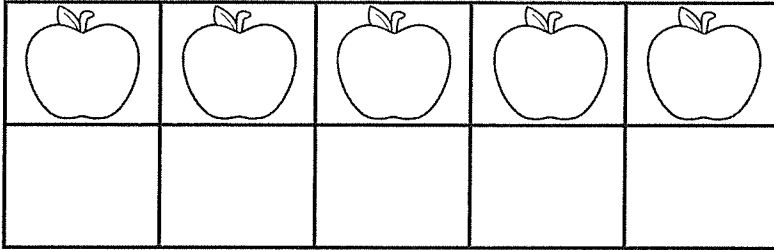

$$\underline{\quad} + \underline{\quad} = 10$$

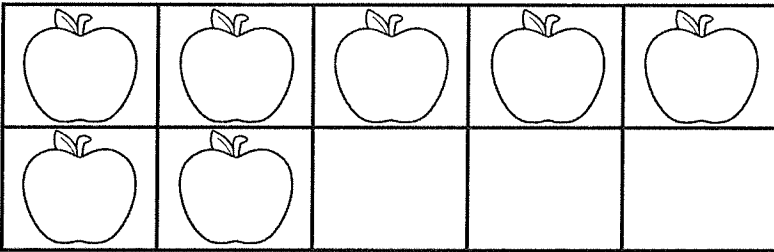

$$\underline{\quad} + \underline{\quad} = 10$$

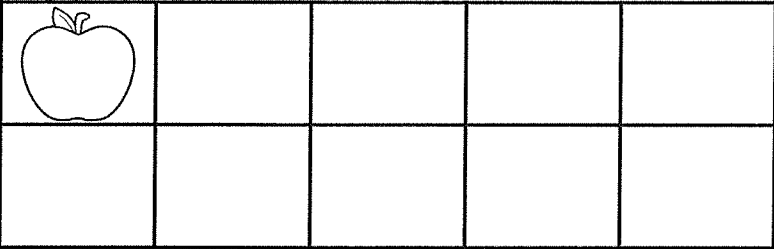

$$\underline{\quad} + \underline{\quad} = 10$$

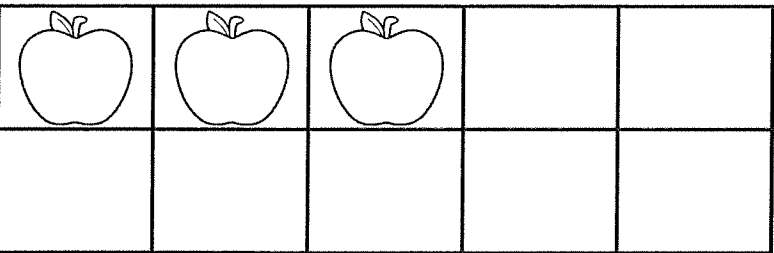

$$\underline{\quad} + \underline{\quad} = 10$$

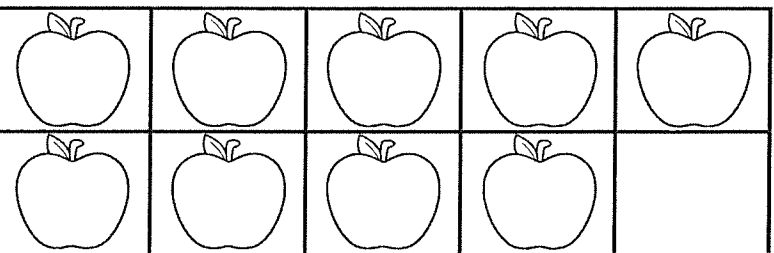

$$\underline{\quad} + \underline{\quad} = 10$$

Name:

--

Which pictures begin with the same sound as...

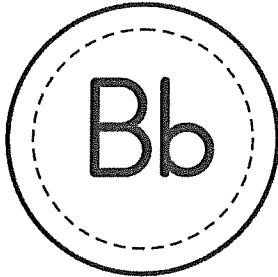

barn

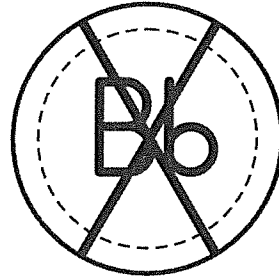
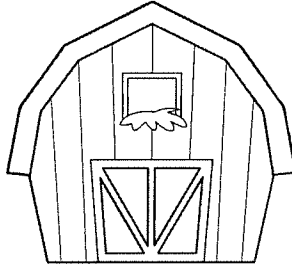

By Lavinia Pop © 2014

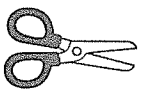

Name:

--

Count the apples. How many more do you need to make 10?

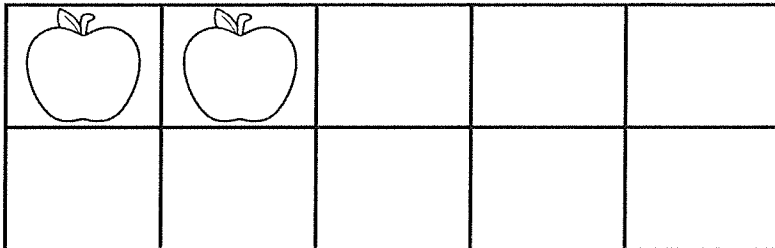

$$\underline{\quad} + \underline{\quad} = 10$$

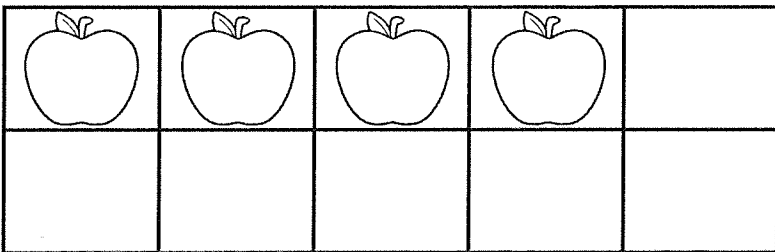

$$\underline{\quad} + \underline{\quad} = 10$$

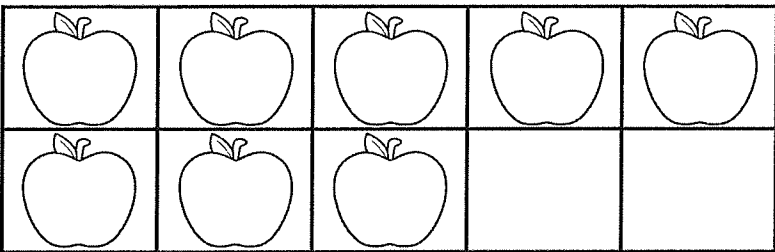

$$\underline{\quad} + \underline{\quad} = 10$$

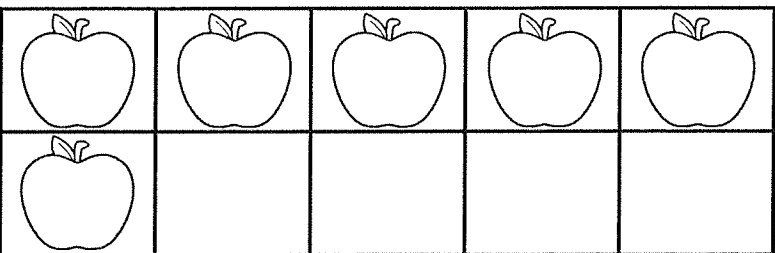

$$\underline{\quad} + \underline{\quad} = 10$$

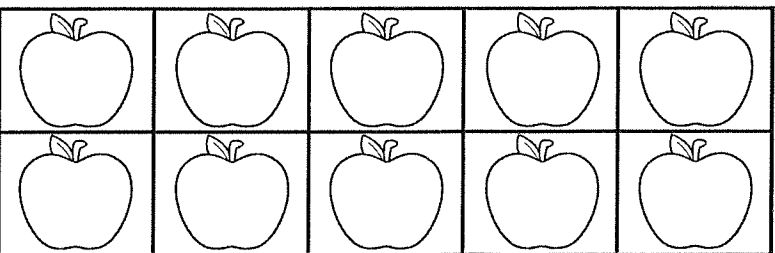

$$\underline{\quad} + \underline{\quad} = 10$$

Name:

--

Which pictures begin with the same sound as...

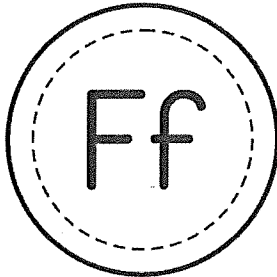

farmer

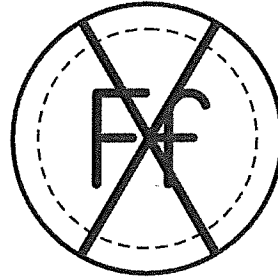

By Lavinia Pop © 2014

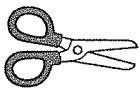

Name: _____

Color by number.

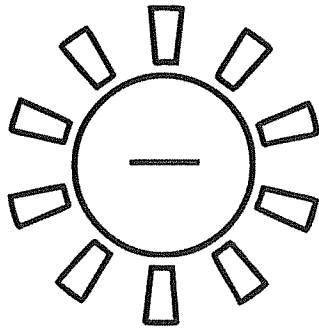

- 1 = yellow
- 2 = gray
- 3 = brown
- 4 = orange
- 5 = black

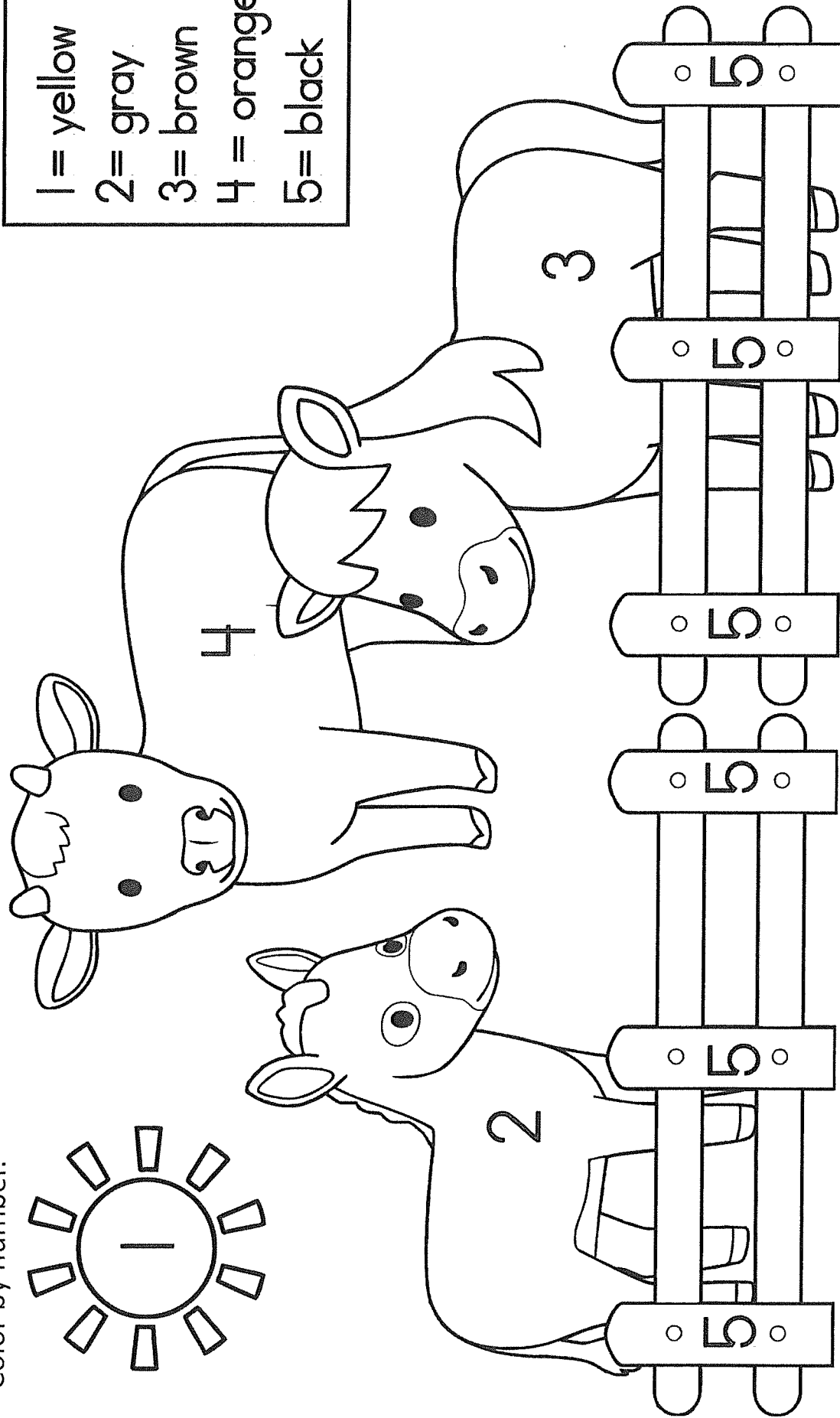

Name: _____

What sound do the pictures begin with?

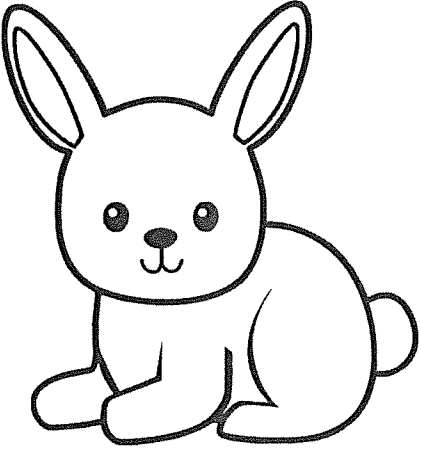
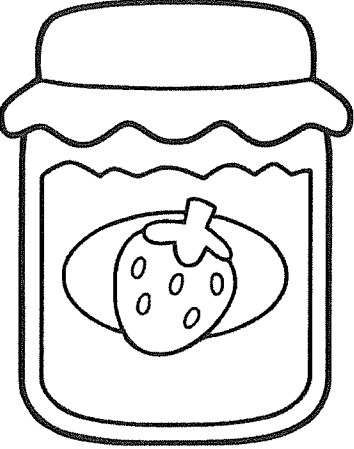
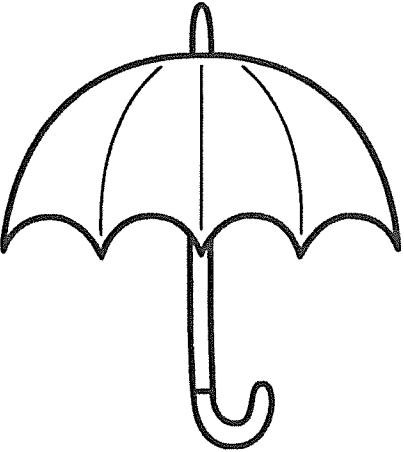
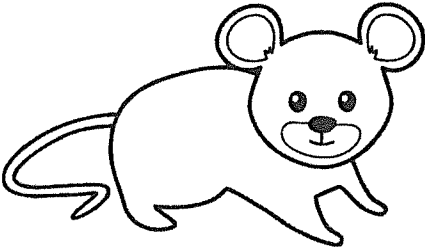
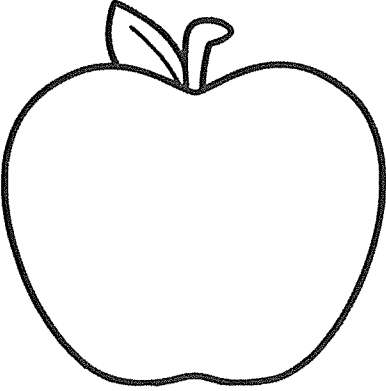
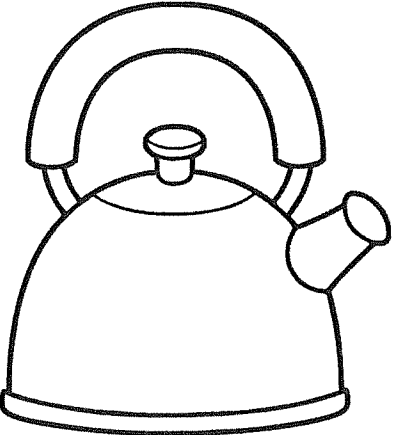
 <p>(r)</p> <p>(w)</p>	 <p>(p)</p> <p>(j)</p>
 <p>(v)</p> <p>(u)</p>	 <p>(m)</p> <p>(o)</p>
 <p>(a)</p> <p>(c)</p>	 <p>(d)</p> <p>(k)</p>

Name:



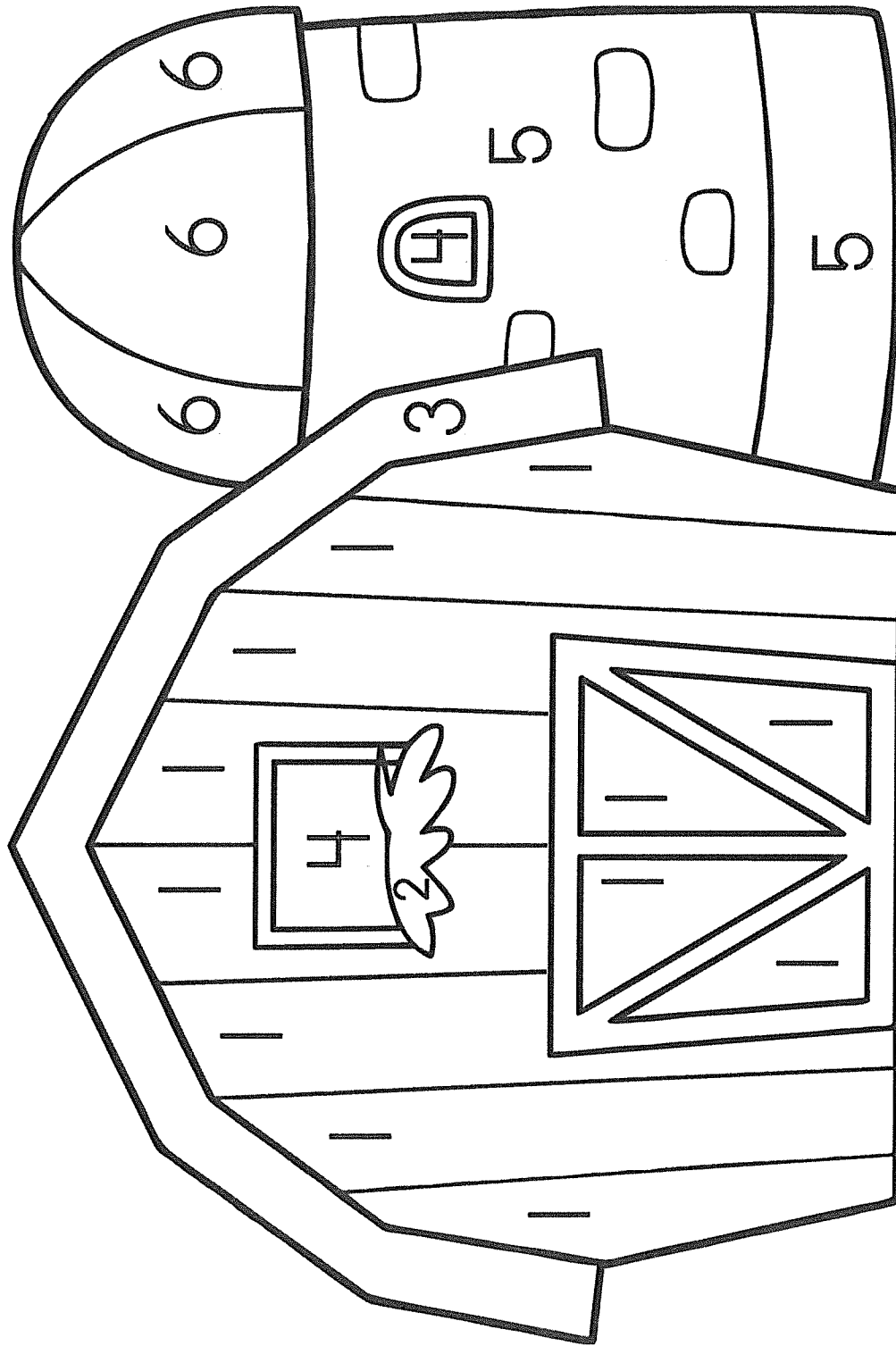

Color by number.

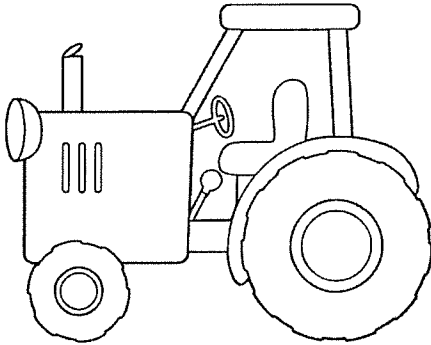

- 1 = red
- 2 = yellow
- 3 = black
- 4 = brown
- 5 = orange
- 6 = gray

Name:

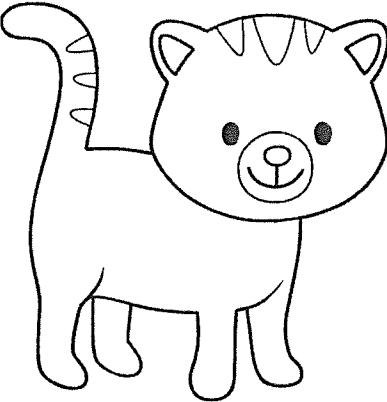
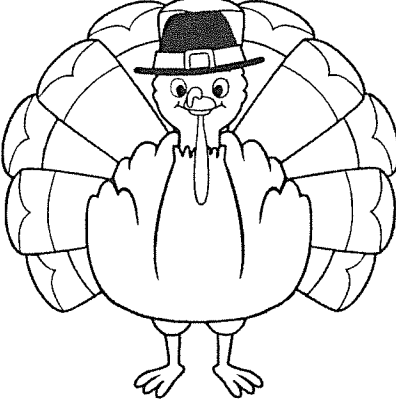
What sound do the pictures begin with?

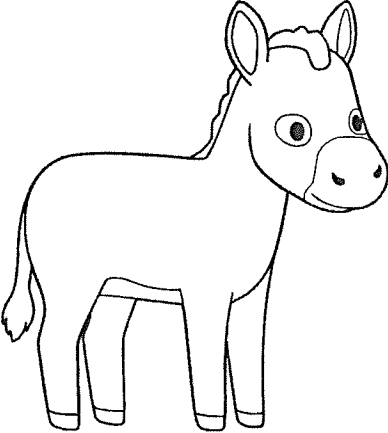
 <p>t</p> <p>b</p>	 <p>w</p> <p>s</p>
 <p>c</p> <p>s</p>	 <p>k</p> <p>t</p>
 <p>v</p> <p>m</p>	 <p>d</p> <p>i</p>

Name:

Color the picture that is heavier.

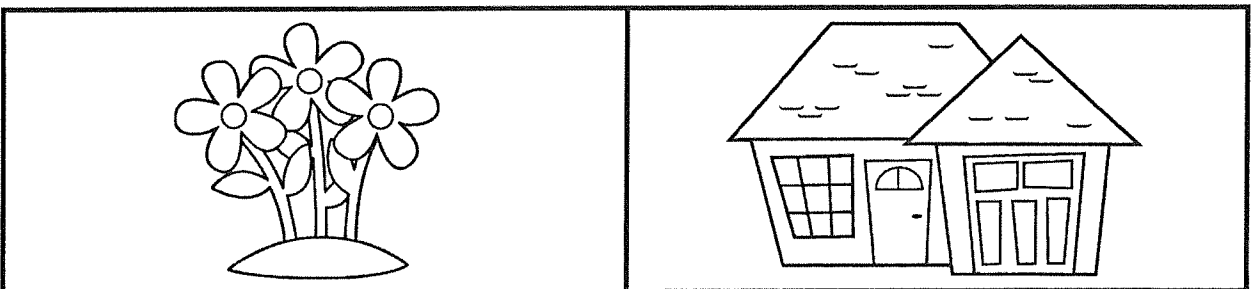
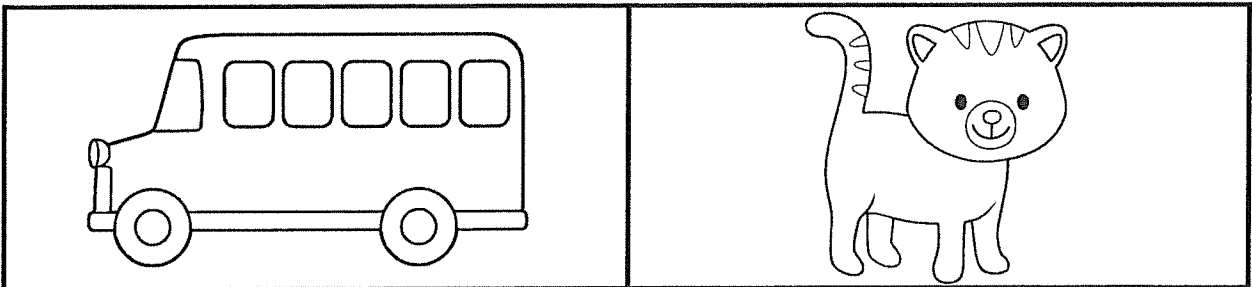
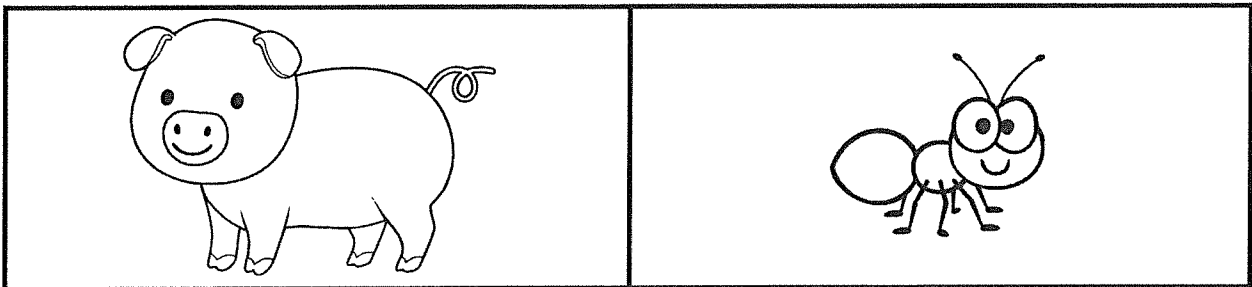
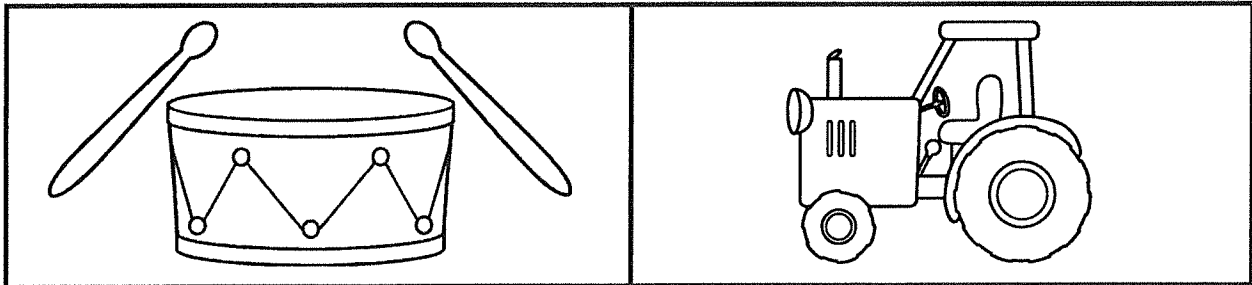
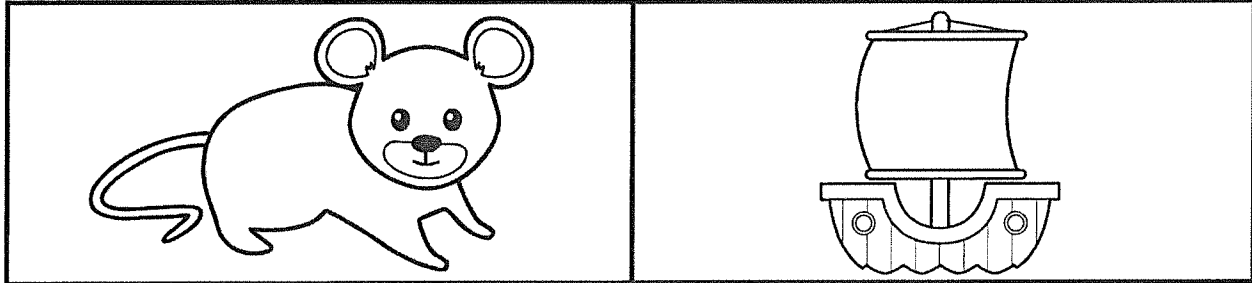

Name:

--

Cut and paste the missing letters.

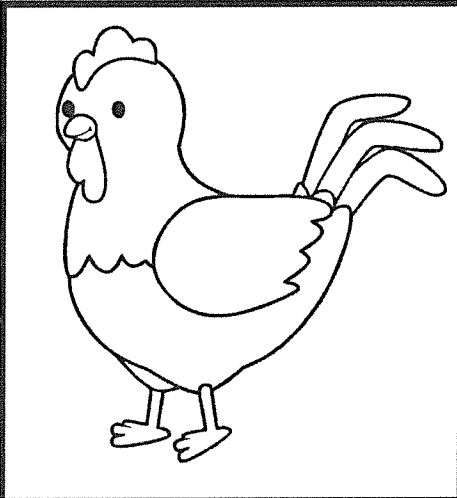
a	b			
	e	f		
g		i	j	
l	m			p
q		s		u
	w	x		z

By Lavinia Pop © 2014

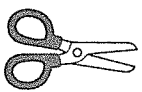

c	r	t	o	h
k	v	d	y	n

Name:

--

Color what is...

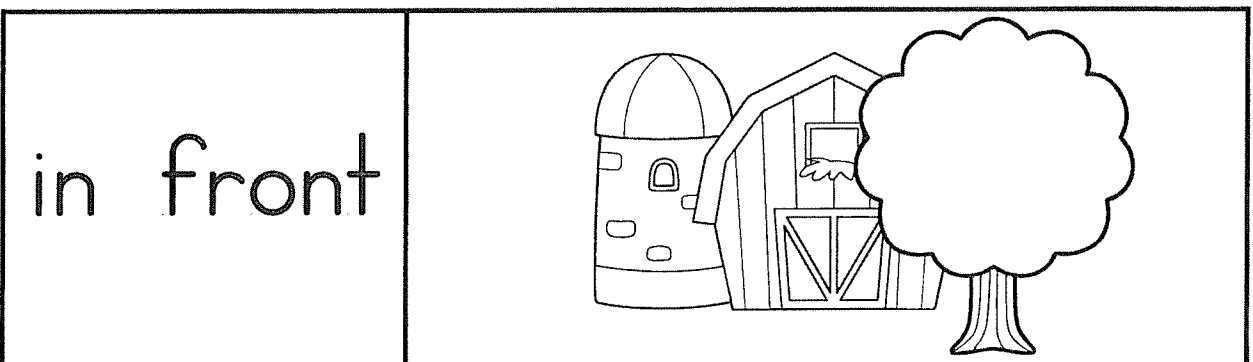
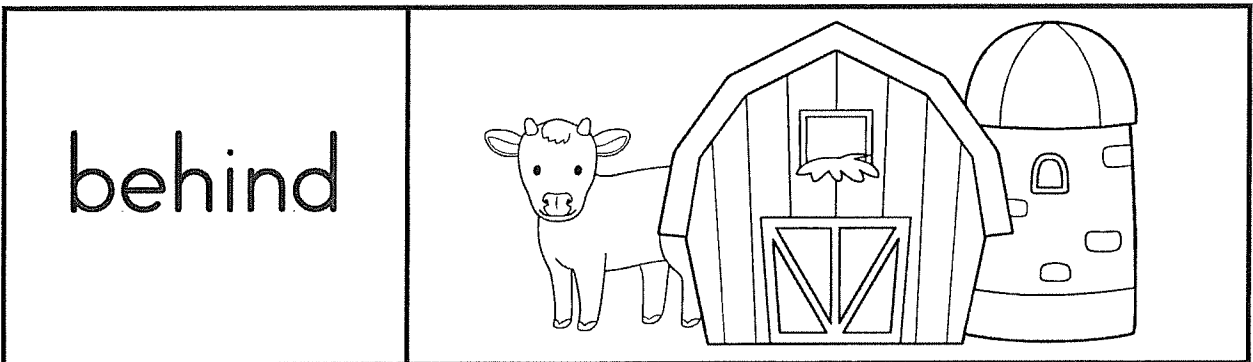
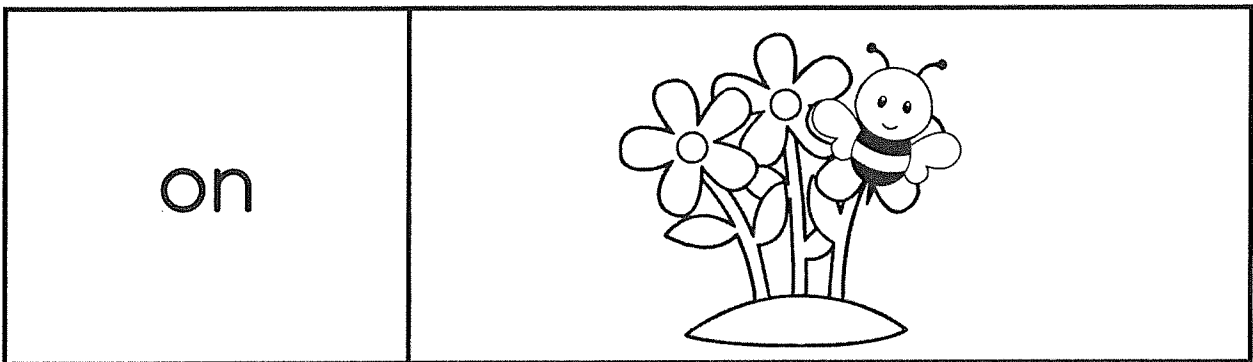
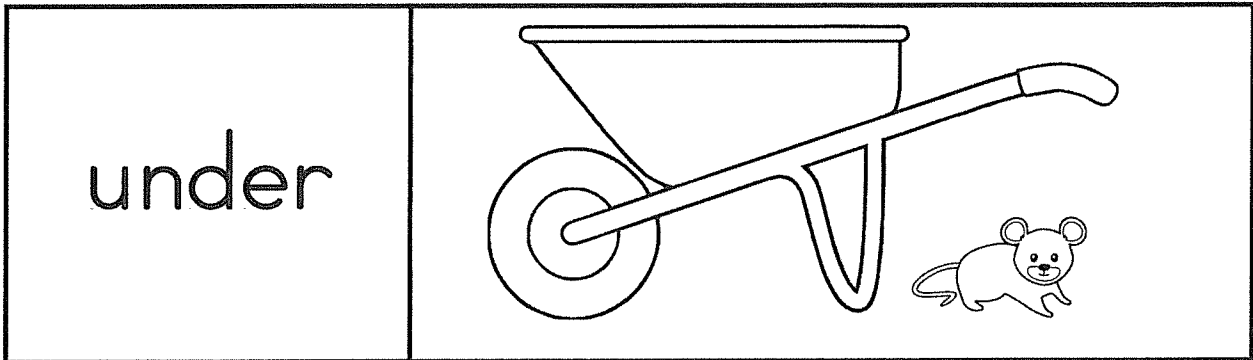

Name: _____

Cut and paste the pictures next to the correct sentence.

I am a pig.

I see a cat.

I like the hen.

I can see the dog.

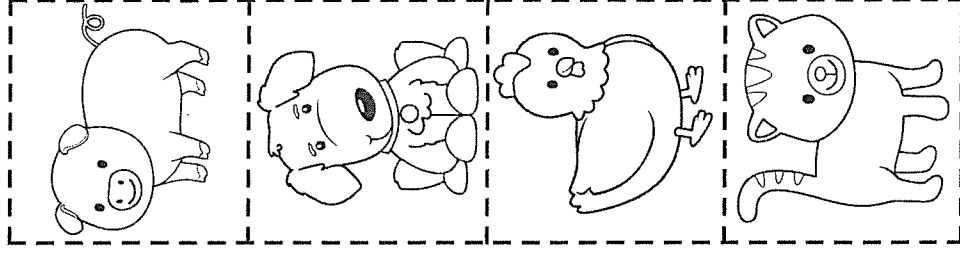
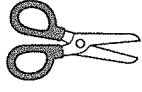

Name:

Cut and paste the missing numbers.

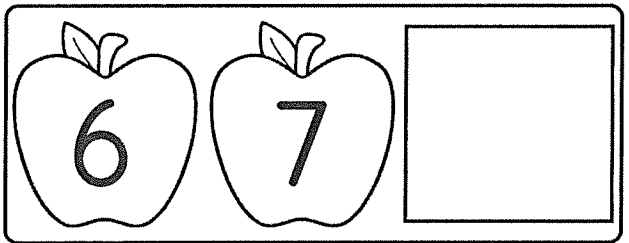
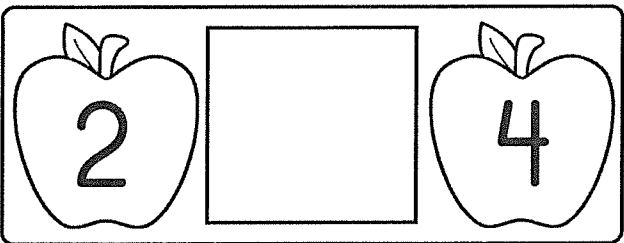
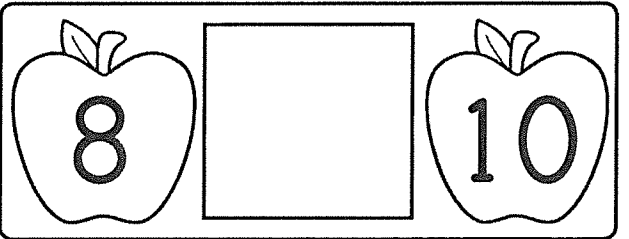
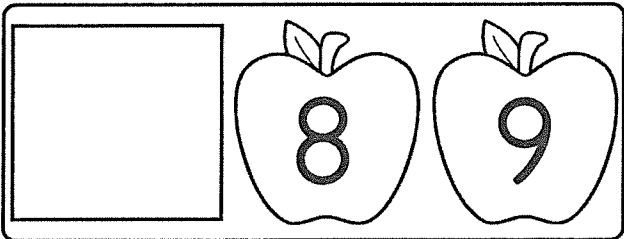
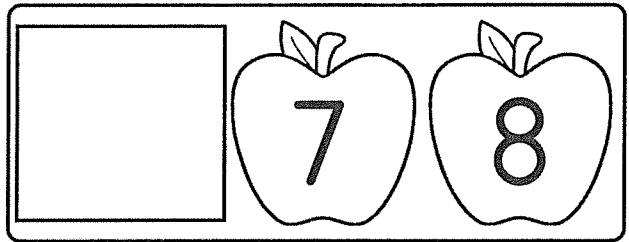
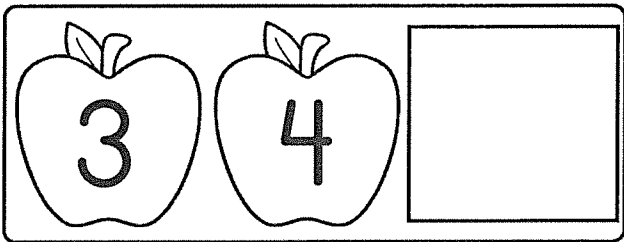
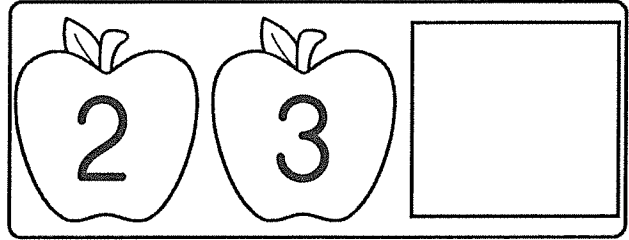
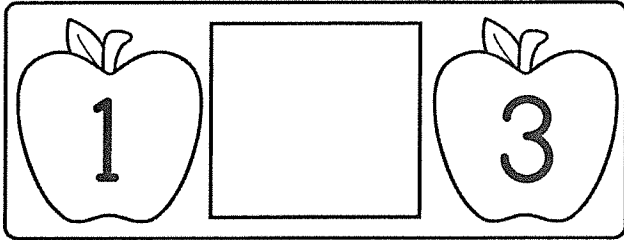

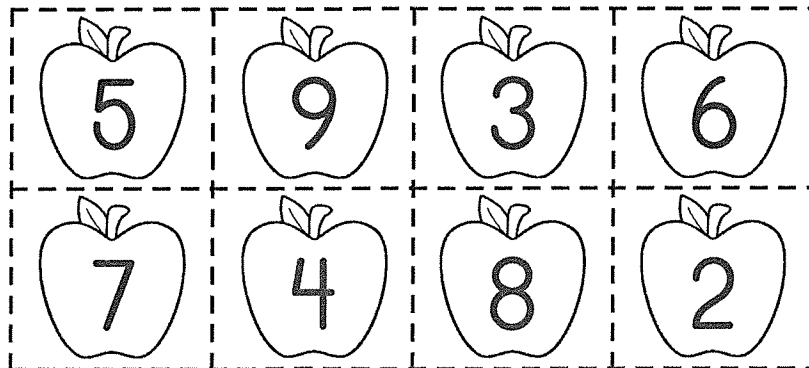
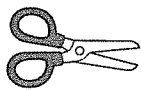

By Lavinia Pop © 2014



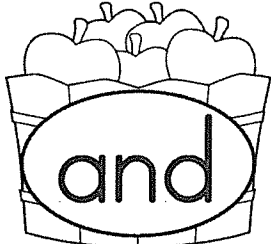

Name:

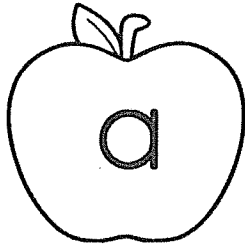
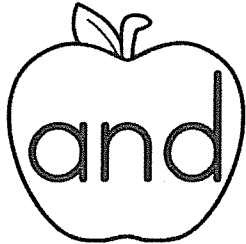
Color the apple that matches the word on the barrel.

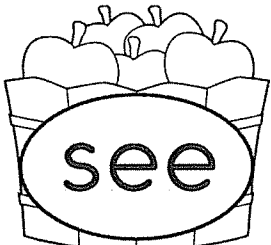
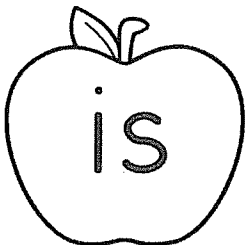
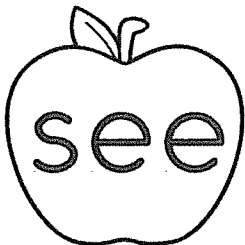
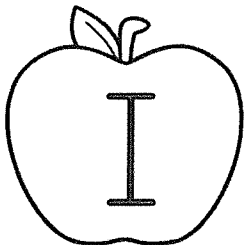
 <p>and</p>	 <p>we</p>	 <p>a</p>	 <p>and</p>
--	---	---	--

 <p>see</p>	 <p>is</p>	 <p>see</p>	 <p>I</p>
--	---	---	--

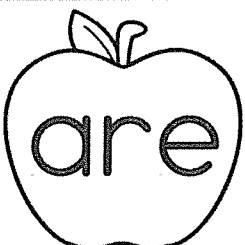
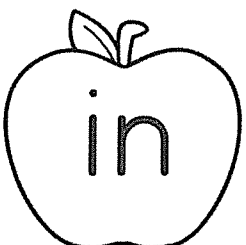
 <p>can</p>	 <p>can</p>	 <p>are</p>	 <p>in</p>
--	--	---	---

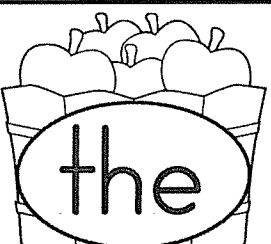
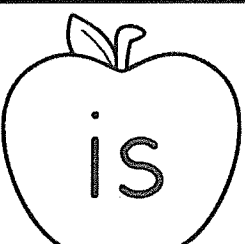
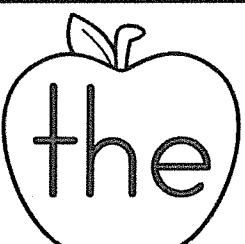
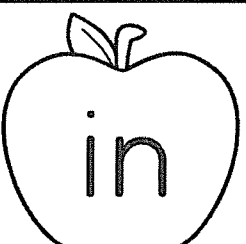
 <p>the</p>	 <p>is</p>	 <p>the</p>	 <p>in</p>
--	---	---	---

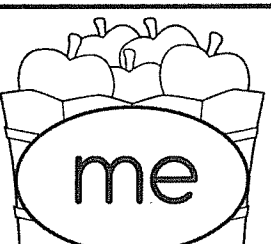
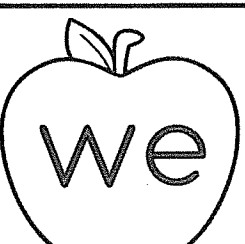
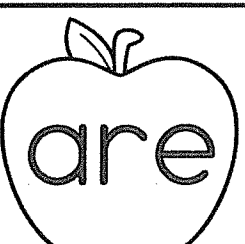
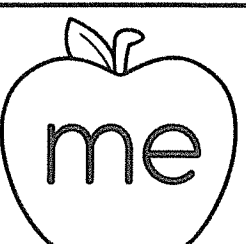
 <p>me</p>	 <p>we</p>	 <p>are</p>	 <p>me</p>
---	---	---	---

Name:

--

Cut and paste the number tiles in the correct order.

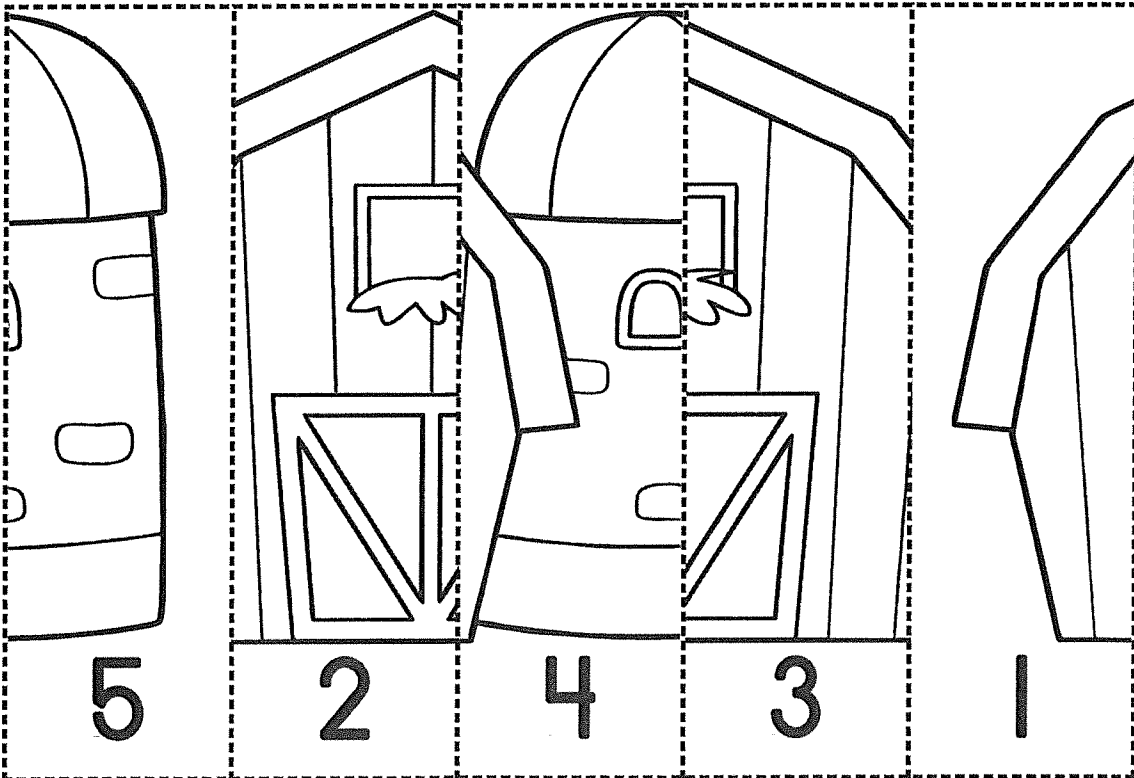

--	--	--	--	--

By Lavinia Pop © 2014

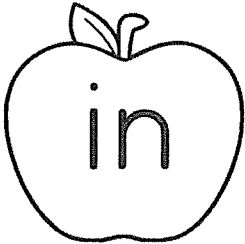

Name: _____

Color the apple that matches the word on the barrel.

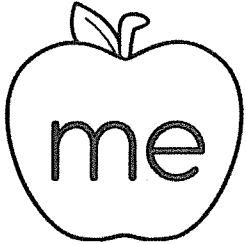
 <p>help</p>			
---	---	--	---

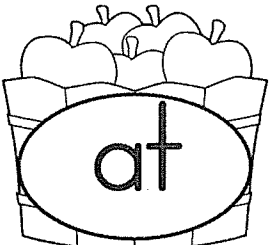
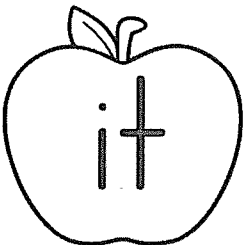
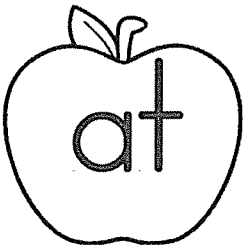
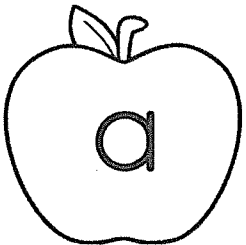
 <p>at</p>			
---	---	--	---

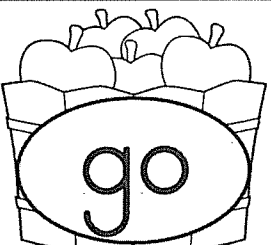
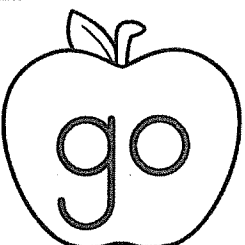
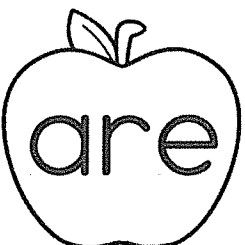
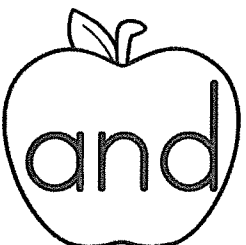
 <p>go</p>			
---	---	--	---

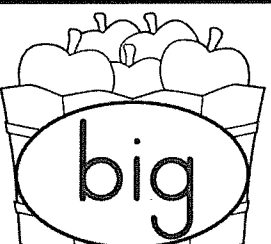
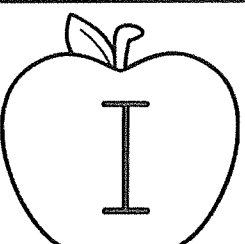
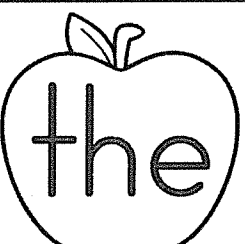
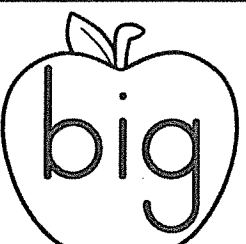
 <p>big</p>			
--	---	--	---

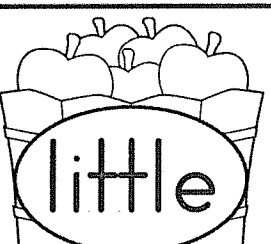
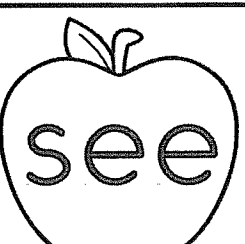
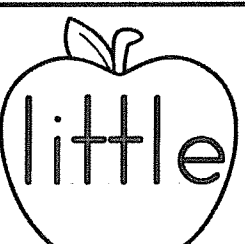
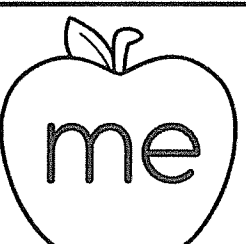
 <p>little</p>			
---	---	--	---

Name:

--

Cut and paste the number tiles in the correct order.

--	--	--	--	--

By Lovinia Pop © 2014

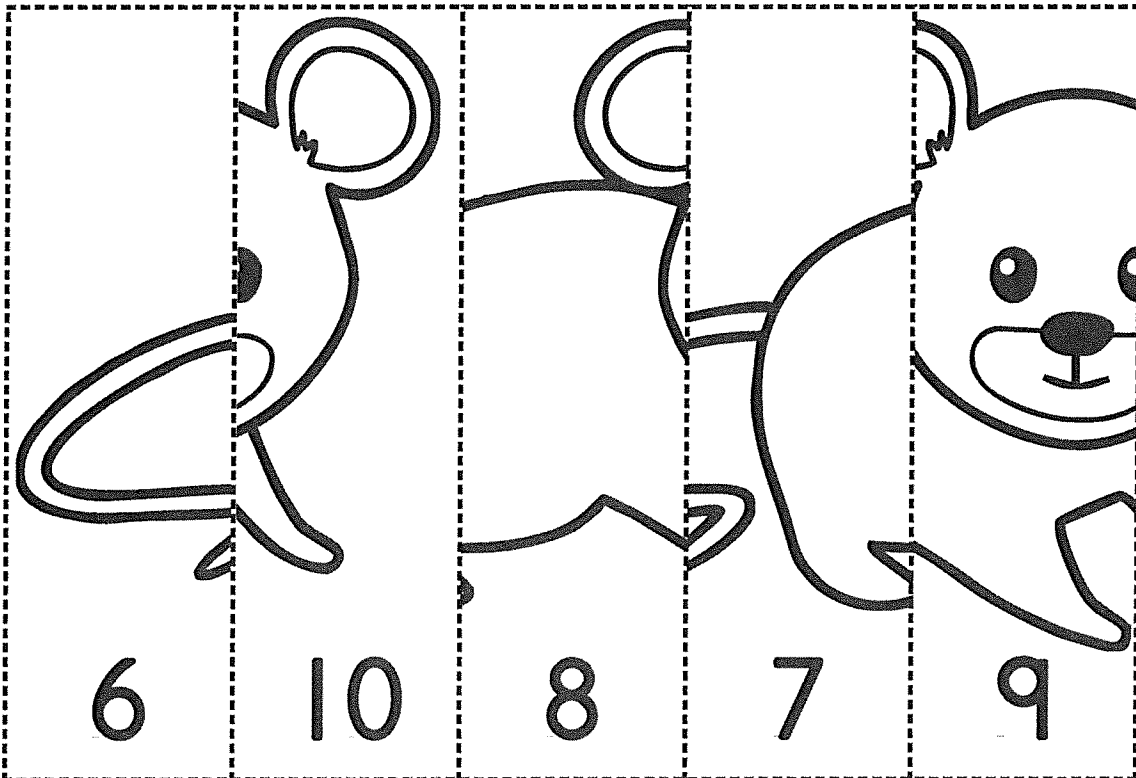

Name: _____

How many syllables?

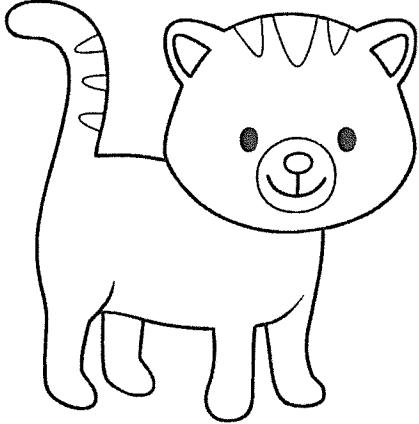
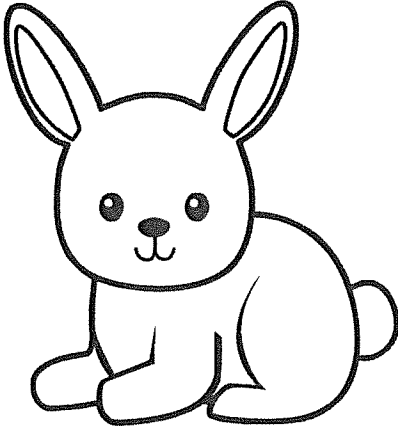
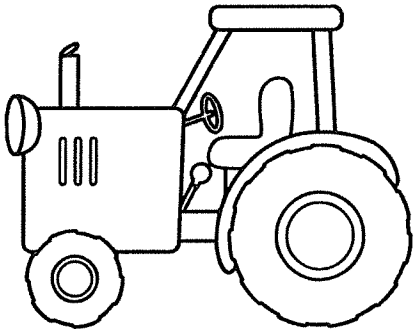
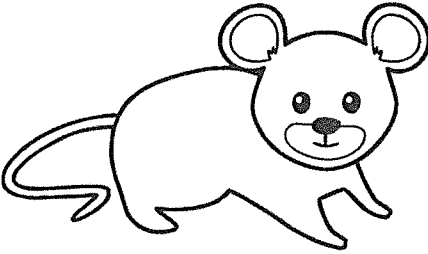
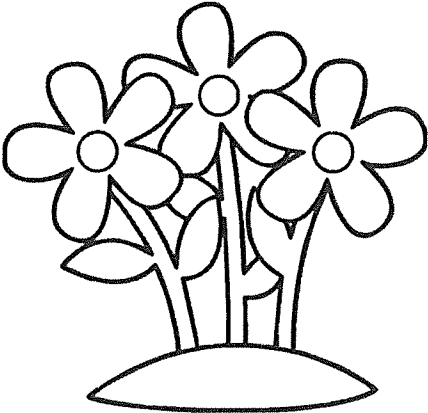
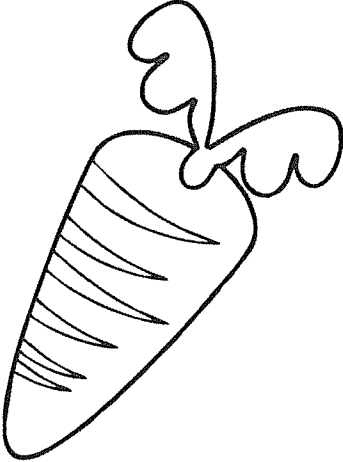
	<p>①</p> <p>②</p> <p>③</p>		<p>①</p> <p>②</p> <p>③</p>
	<p>①</p> <p>②</p> <p>③</p>		<p>①</p> <p>②</p> <p>③</p>
	<p>①</p> <p>②</p> <p>③</p>		<p>①</p> <p>②</p> <p>③</p>

Name: _____

Cut and paste the pictures to complete each pattern.

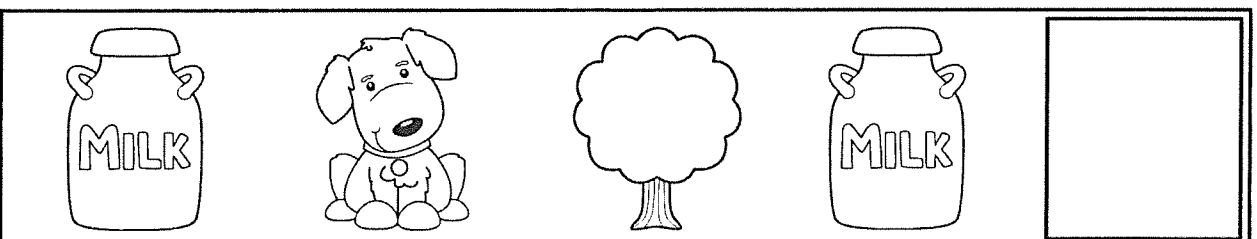
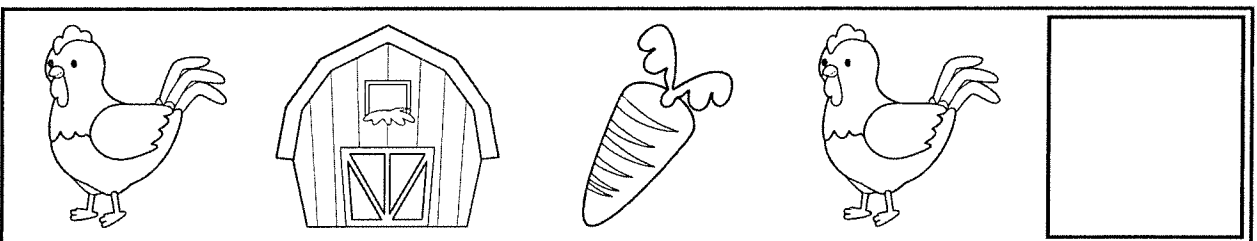
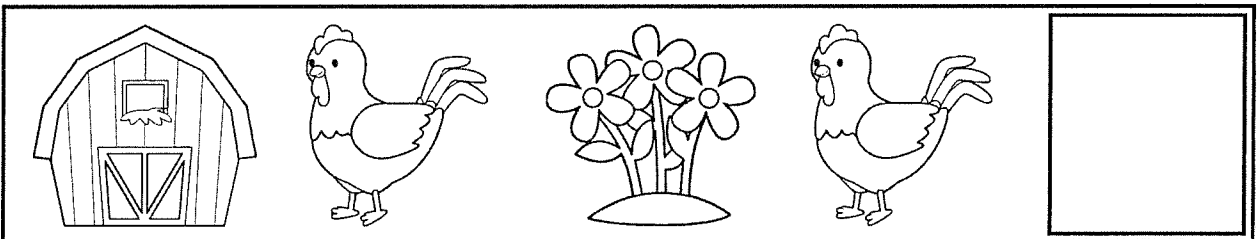
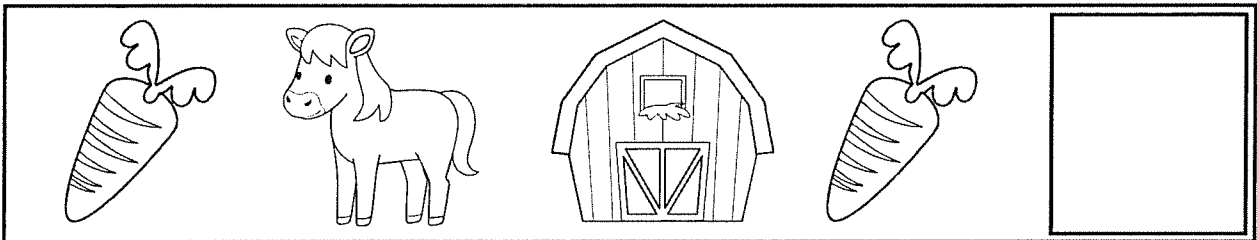
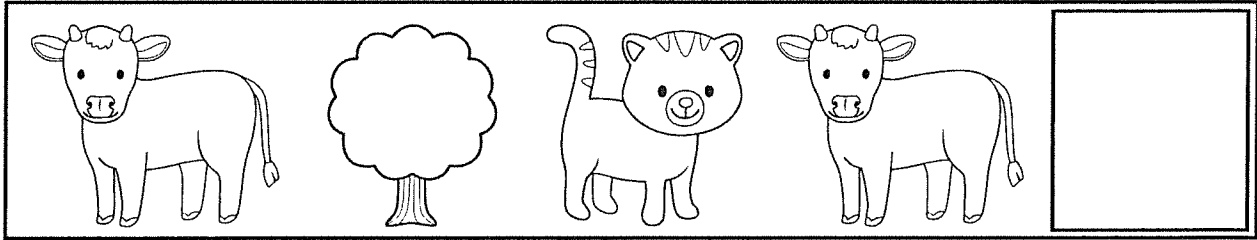

By Lavinia Pop © 2014

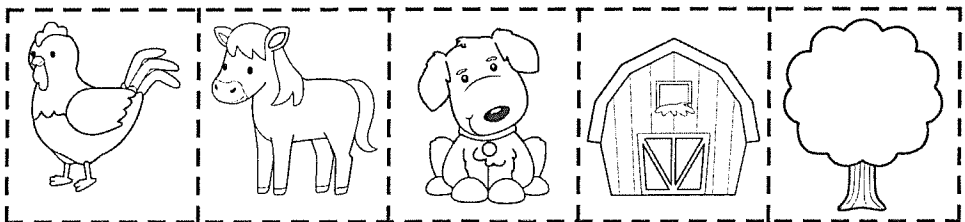
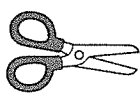

Name:

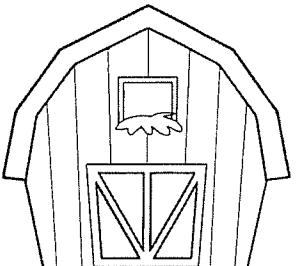
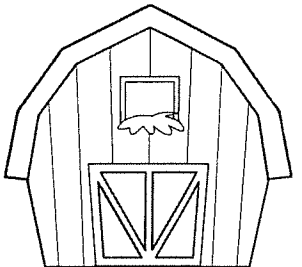
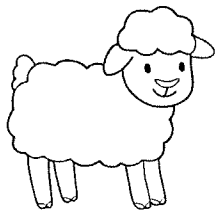
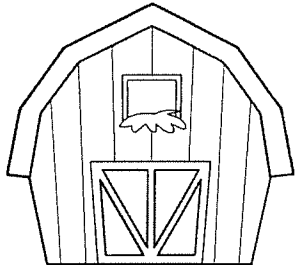
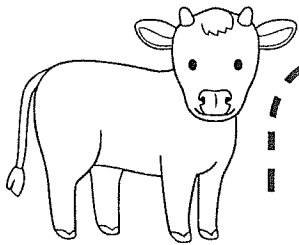
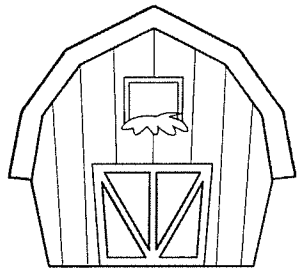
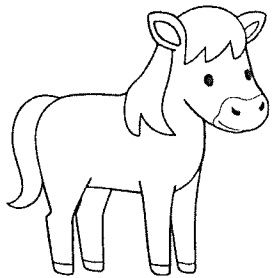
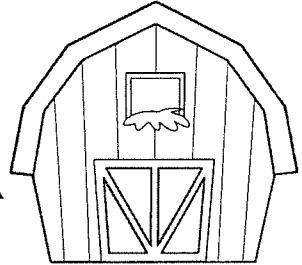
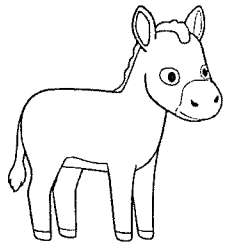

Trace the lines to help the animals into the barn.



Name:

--

Cut and paste the pictures in the correct category.

 <p data-bbox="375 453 581 512">Animals</p>	<p data-bbox="1029 453 1182 512">Plants</p> 
--	---

--	--

By Lavinia Pop © 2014

